

# Dorado *gold*

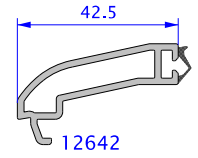

## TEKNİK KATALOG

	<u>sayfa no</u>
Sistem Tanıtımı	1.1 – 1.3
Ana Profiller	2.1 – 2.9
Kesitler	3.1 – 3.60

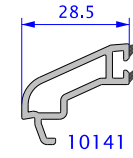
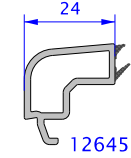
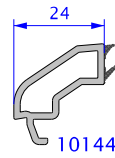
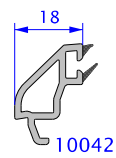
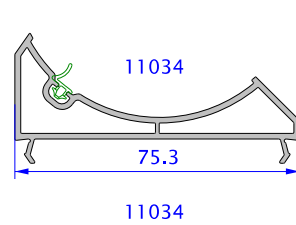
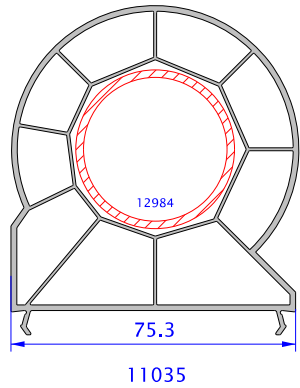
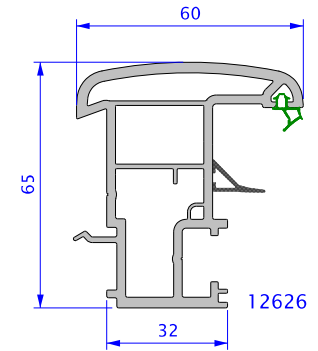
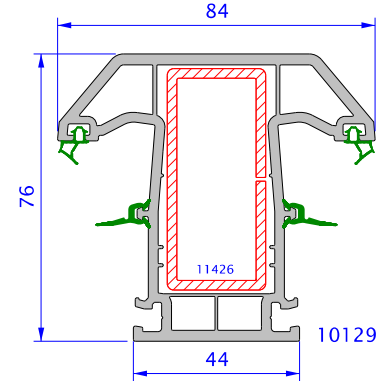
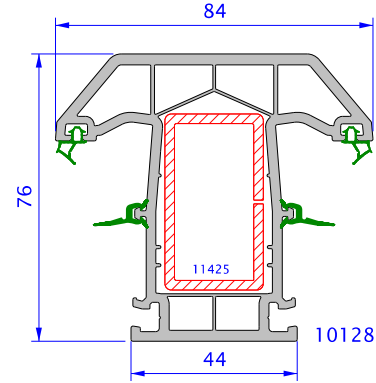
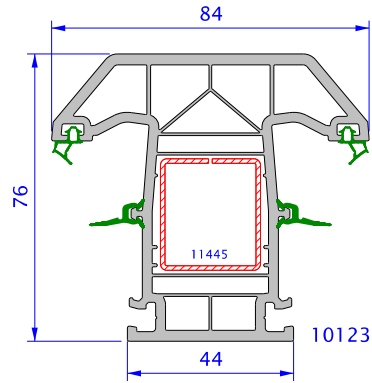
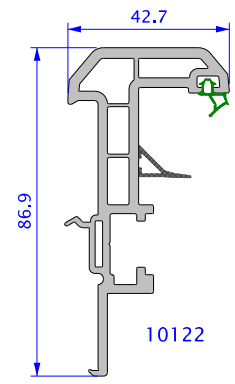
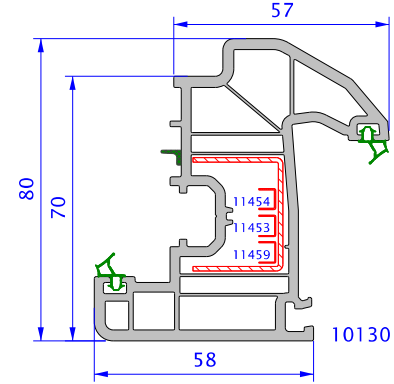
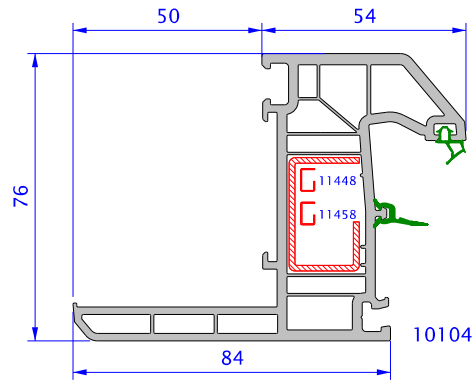
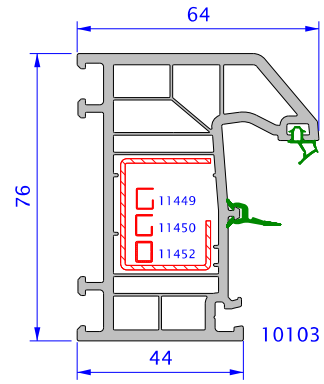

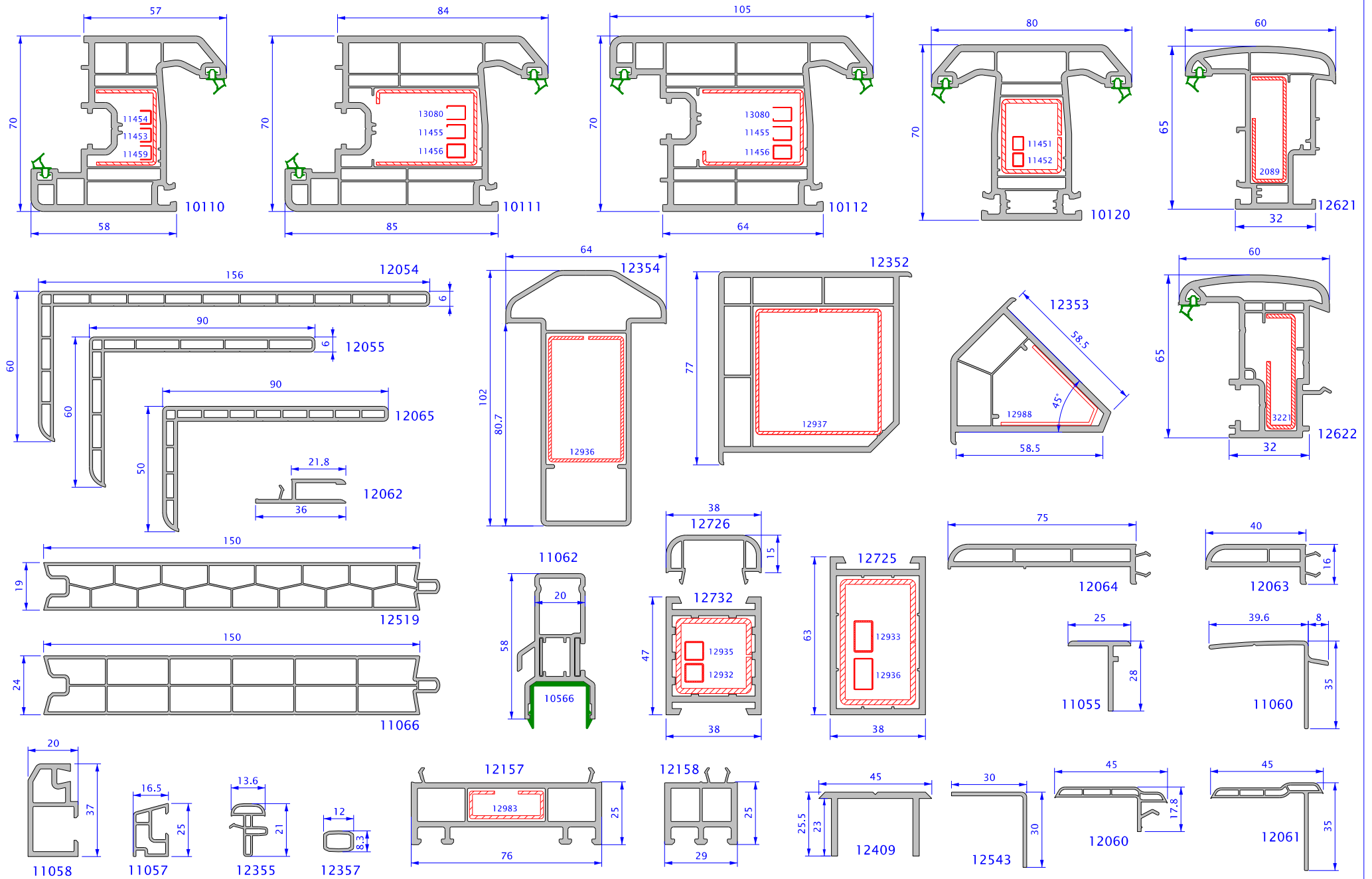

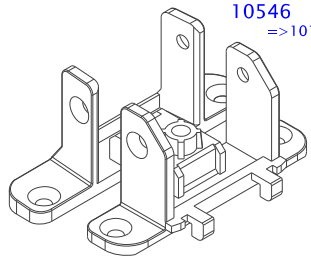

10546  
=>10123/10128/10129

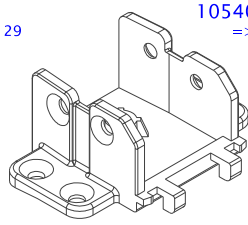

10540  
=>10120

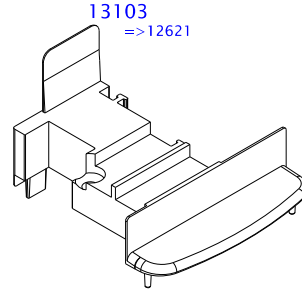

13103  
=>12621

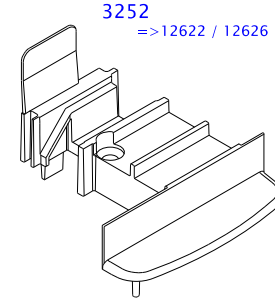

3252  
=>12622 / 12626

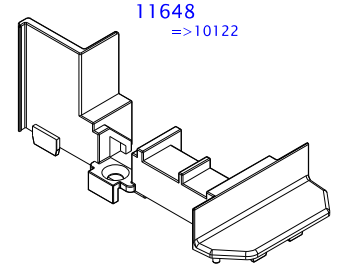

11648  
=>10122

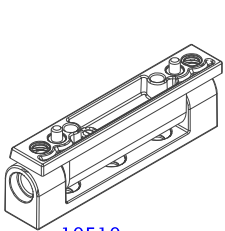

10510

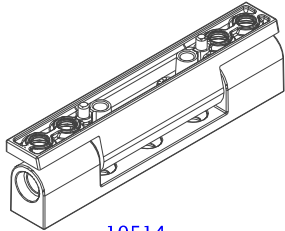

10514

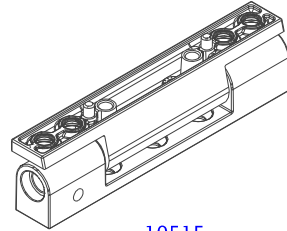

10515

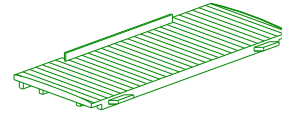

13106

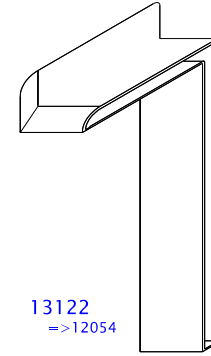

13122  
=>12054

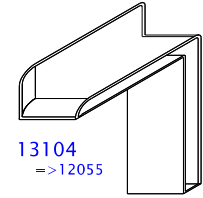

13104  
=>12055

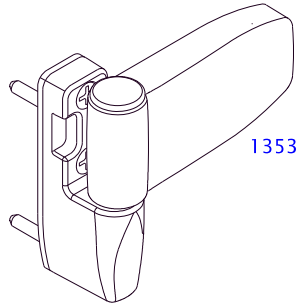

13538

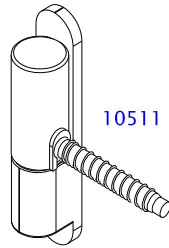

10511

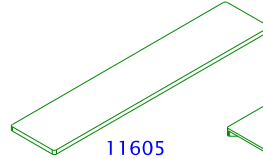

11605

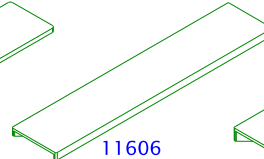

11606

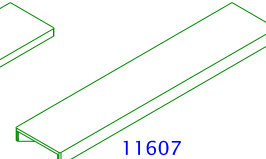

11607



11600



10579

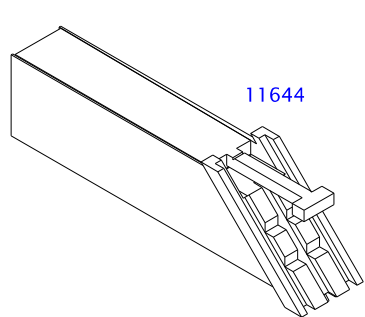

11644

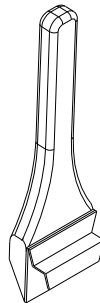

10415

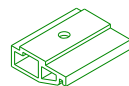

11618

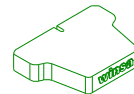

11620



11601



11619



10460  
=>11057/11058



10463



10407



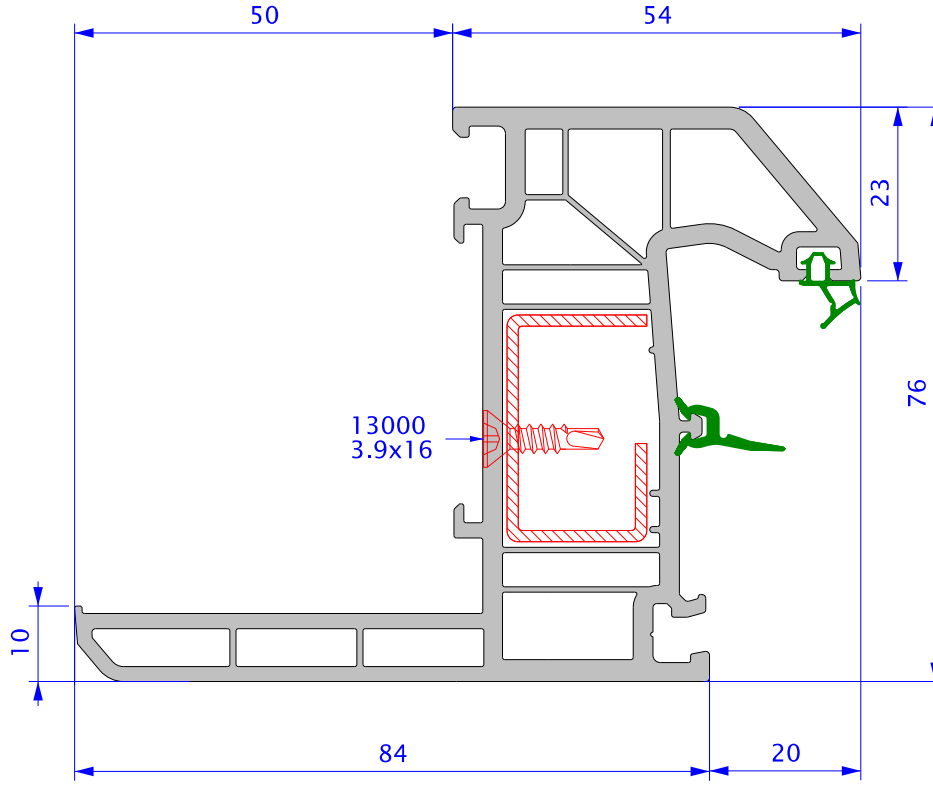

10104	
Ix (cm <sup>4</sup> )	Iy (cm <sup>4</sup> )
77.59	57.88

Destek Sacı		s (mm)	Ix (cm <sup>4</sup> )	Iy (cm <sup>4</sup> )
11448 18.5x30x18.5x13		1.2	1.17	0.43
11458 18.5x30x18.5x13		1.5	1.45	0.53

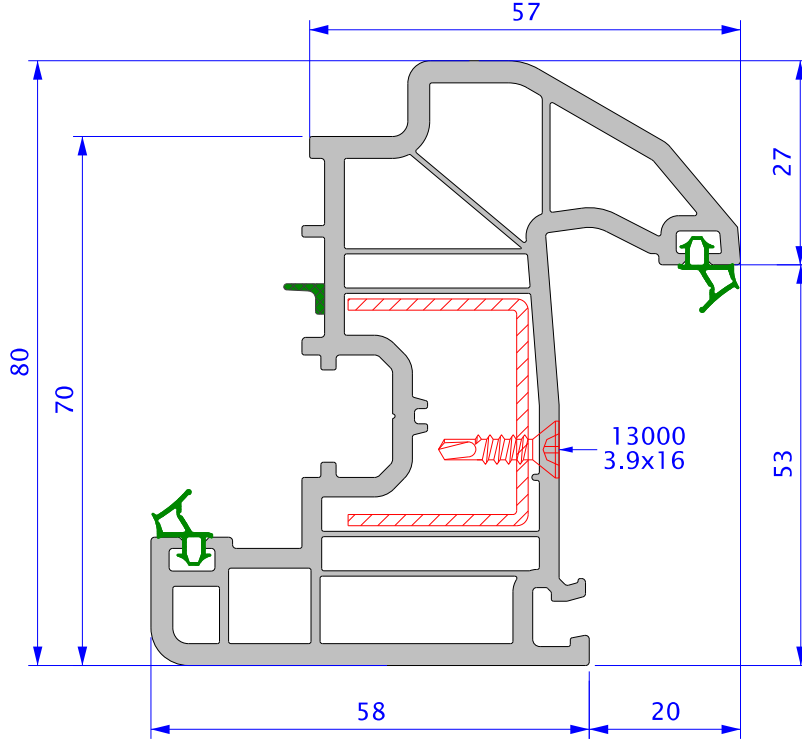

10130	
Ix (cm <sup>4</sup> )	Iy (cm <sup>4</sup> )
71.47	37.18

Destek Sacı		s (mm)	Ix (cm <sup>4</sup> )	Iy (cm <sup>4</sup> )
11459 23.8x30x23.8		1.2	1.37	0.53
11453 23.8x30x23.8		1.5	1.66	0.64
11454 23.8x30x23.8		2	2.10	0.83



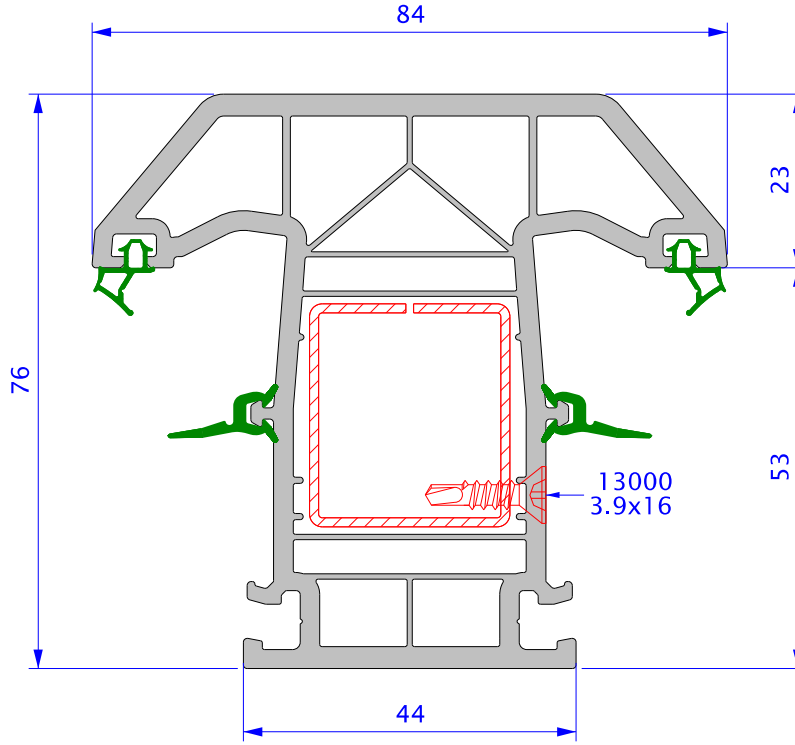

10123	
Ix (cm <sup>4</sup> )	Iy (cm <sup>4</sup> )
70.03	44.48

Destek Sacı		s (mm)	Ix (cm <sup>4</sup> )	Iy (cm <sup>4</sup> )
11445 26.5x29.5		1.2	1.60	1.37

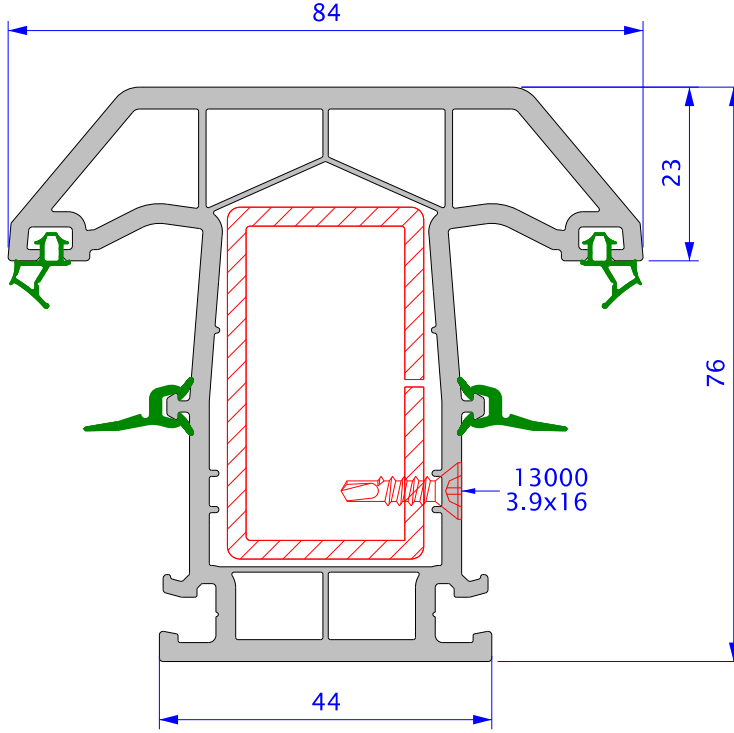

10128	
Ix (cm <sup>4</sup> )	Iy (cm <sup>4</sup> )
68.28	43.55

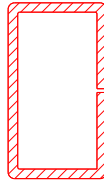
Destek Sacı		s (mm)	Ix (cm <sup>4</sup> )	Iy (cm <sup>4</sup> )
11425 26x46.5		2.5	9.15	3.53

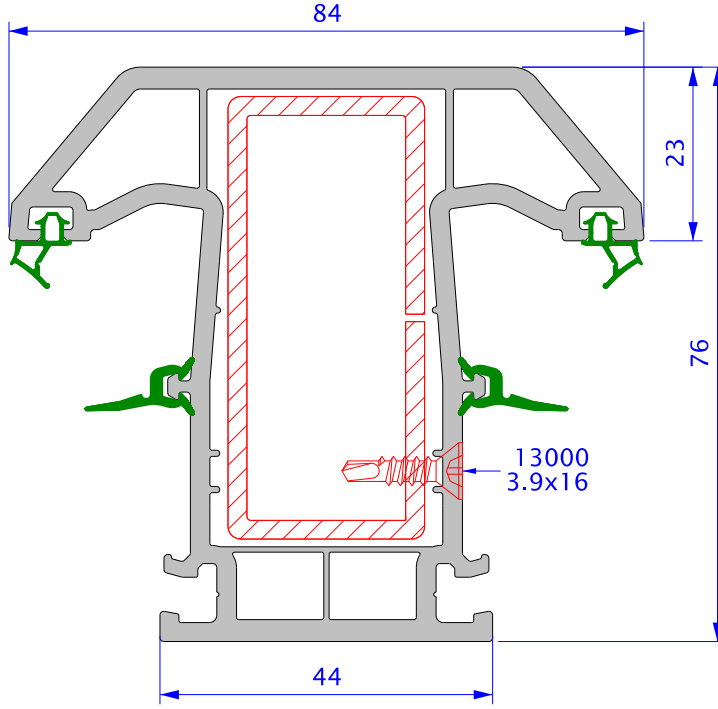

10129	
Ix (cm <sup>4</sup> )	Iy (cm <sup>4</sup> )
67.08	43.89

Destek Sacı		s (mm)	Ix (cm <sup>4</sup> )	Iy (cm <sup>4</sup> )
11426 26x58.5		2.5	16.38	4.36

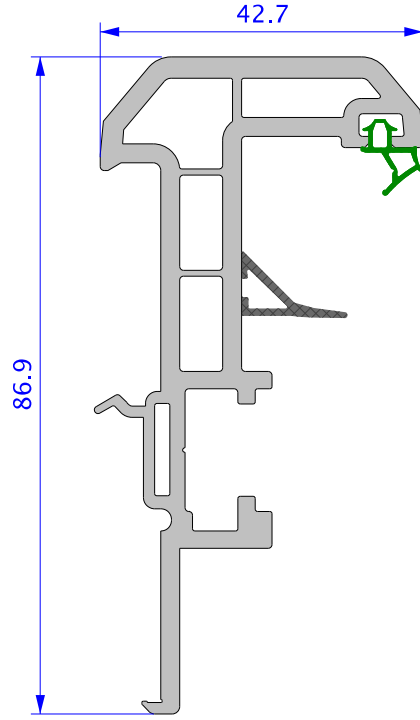

10122	
Ix (cm <sup>4</sup> )	Iy (cm <sup>4</sup> )
38.30	6.03

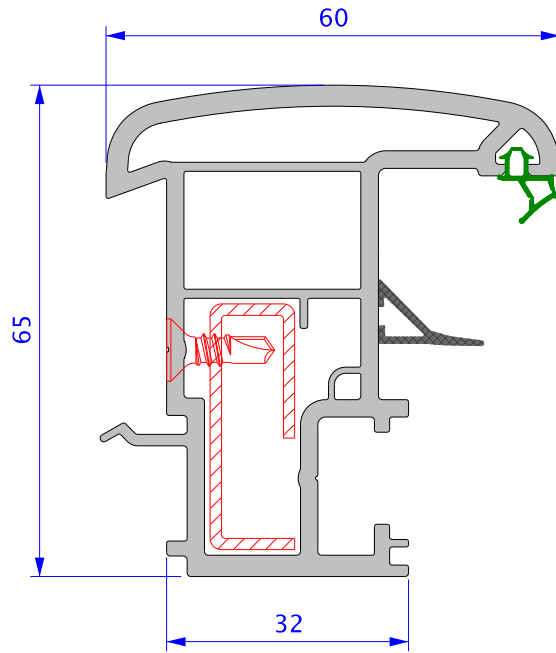

12626	
Ix (cm <sup>4</sup> )	Iy (cm <sup>4</sup> )
34.8	16.29

## Kanat Adaptör Kapak

## Destek Sacı

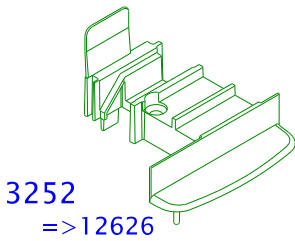
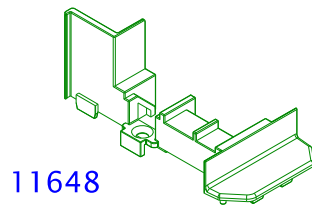
s  
(mm)Ix  
(cm<sup>4</sup>)Iy  
(cm<sup>4</sup>)3252  
=>1262611648  
=>1012211442  
11.2x32.5x11.2x17.7

1.5

1.23

0.18

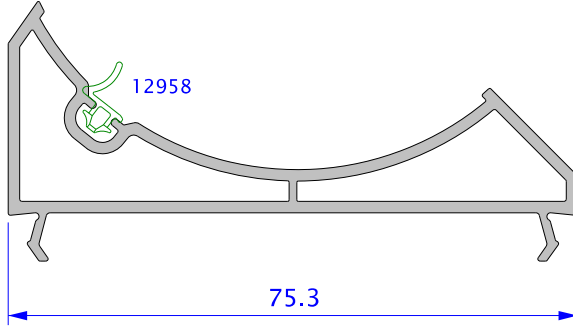

11034	
Ix (cm <sup>4</sup> )	Iy (cm <sup>4</sup> )
38.30	6.03

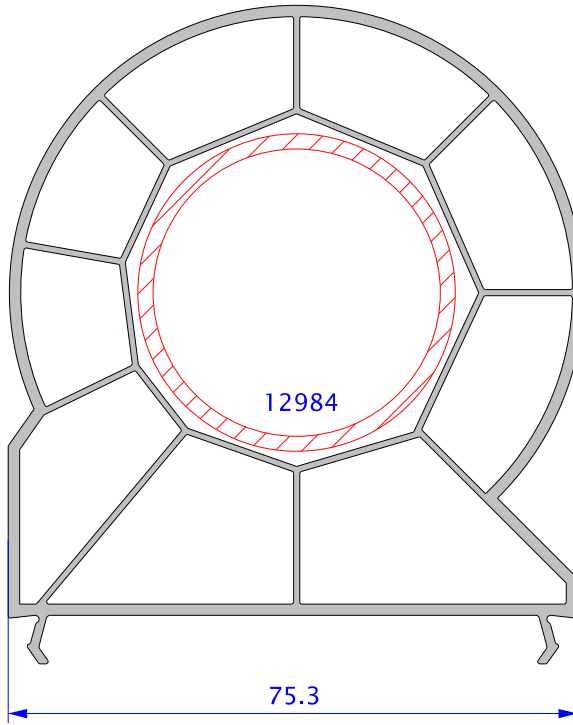

11035	
Ix (cm <sup>4</sup> )	Iy (cm <sup>4</sup> )
38.30	6.03

Destek Sacı		s (mm)	Ix (cm <sup>4</sup> )	Iy (cm <sup>4</sup> )
12984 Ø 40		2	5.03	5.03

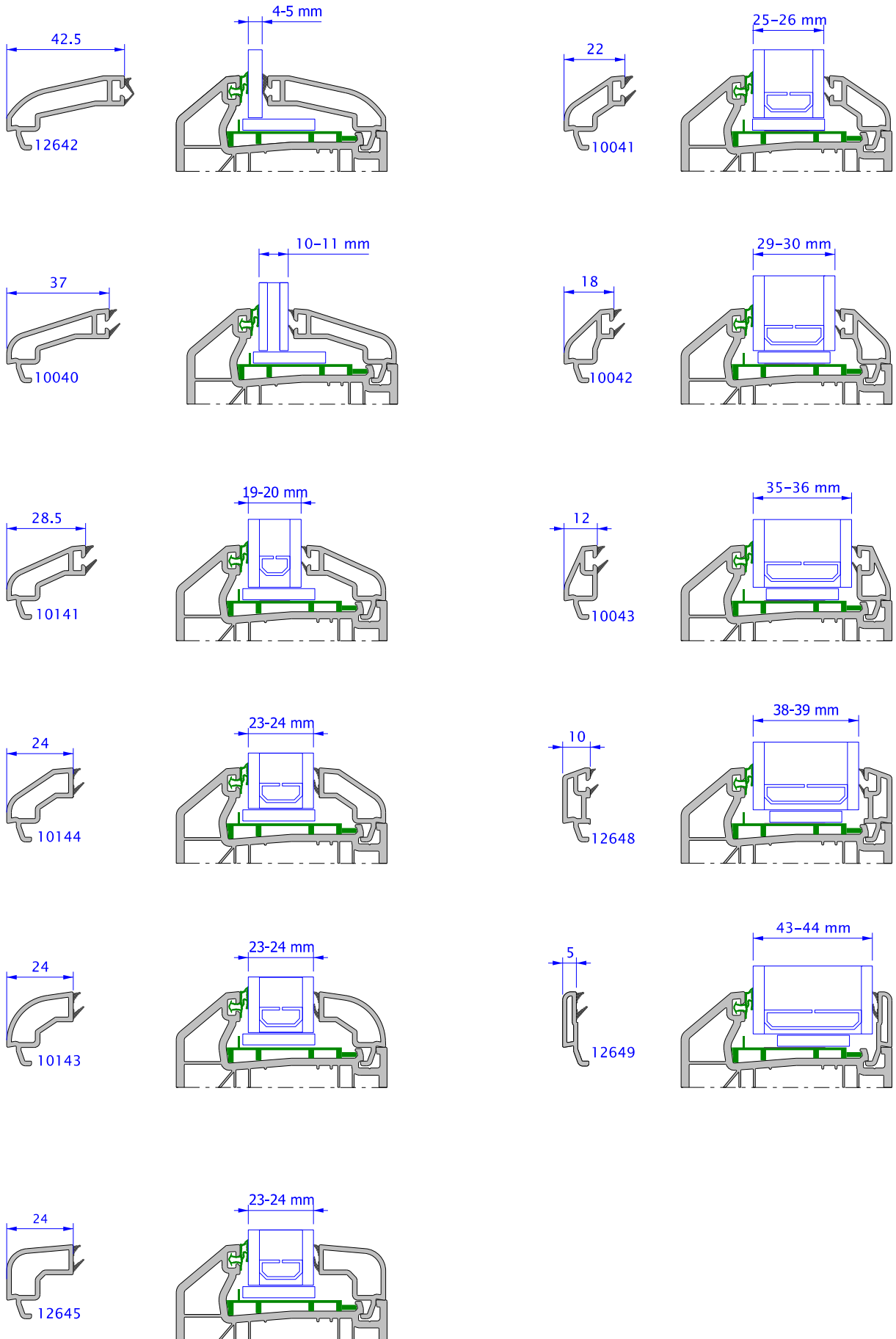

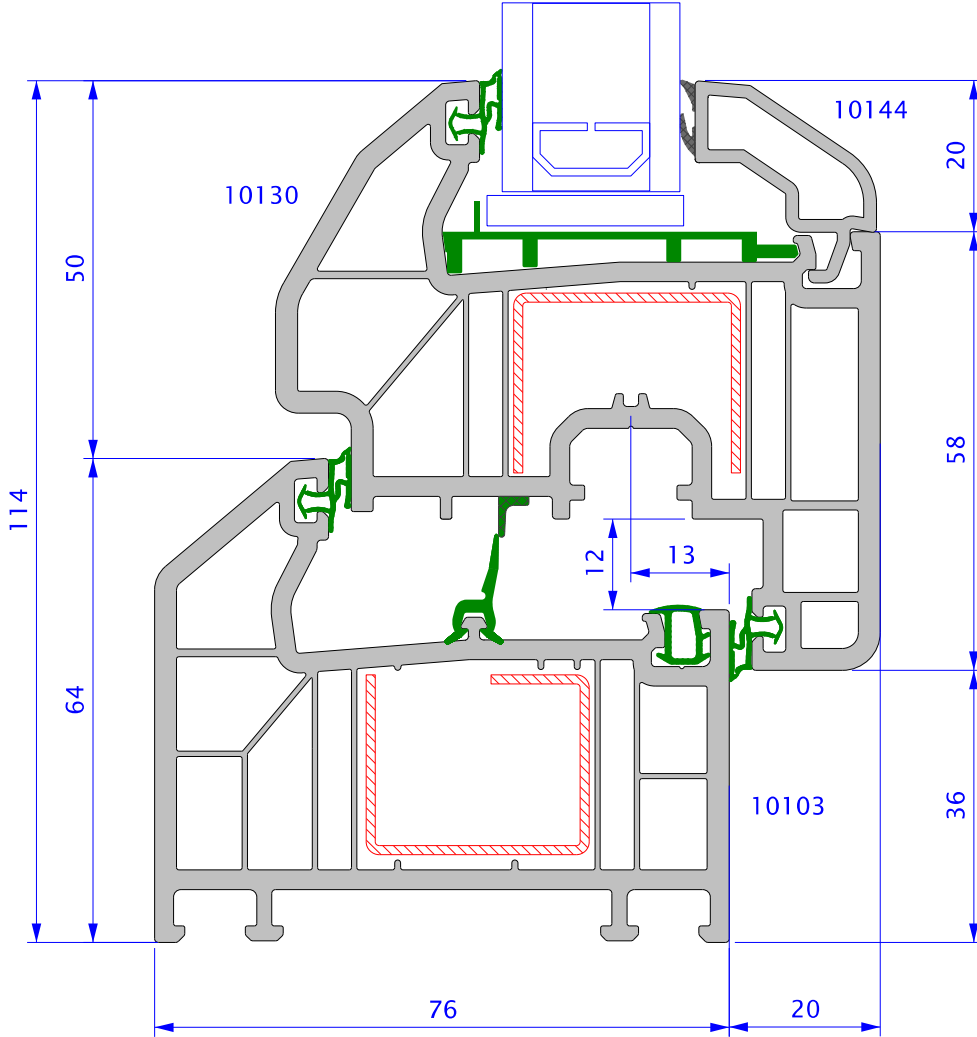
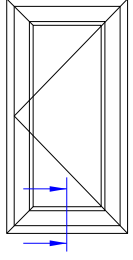





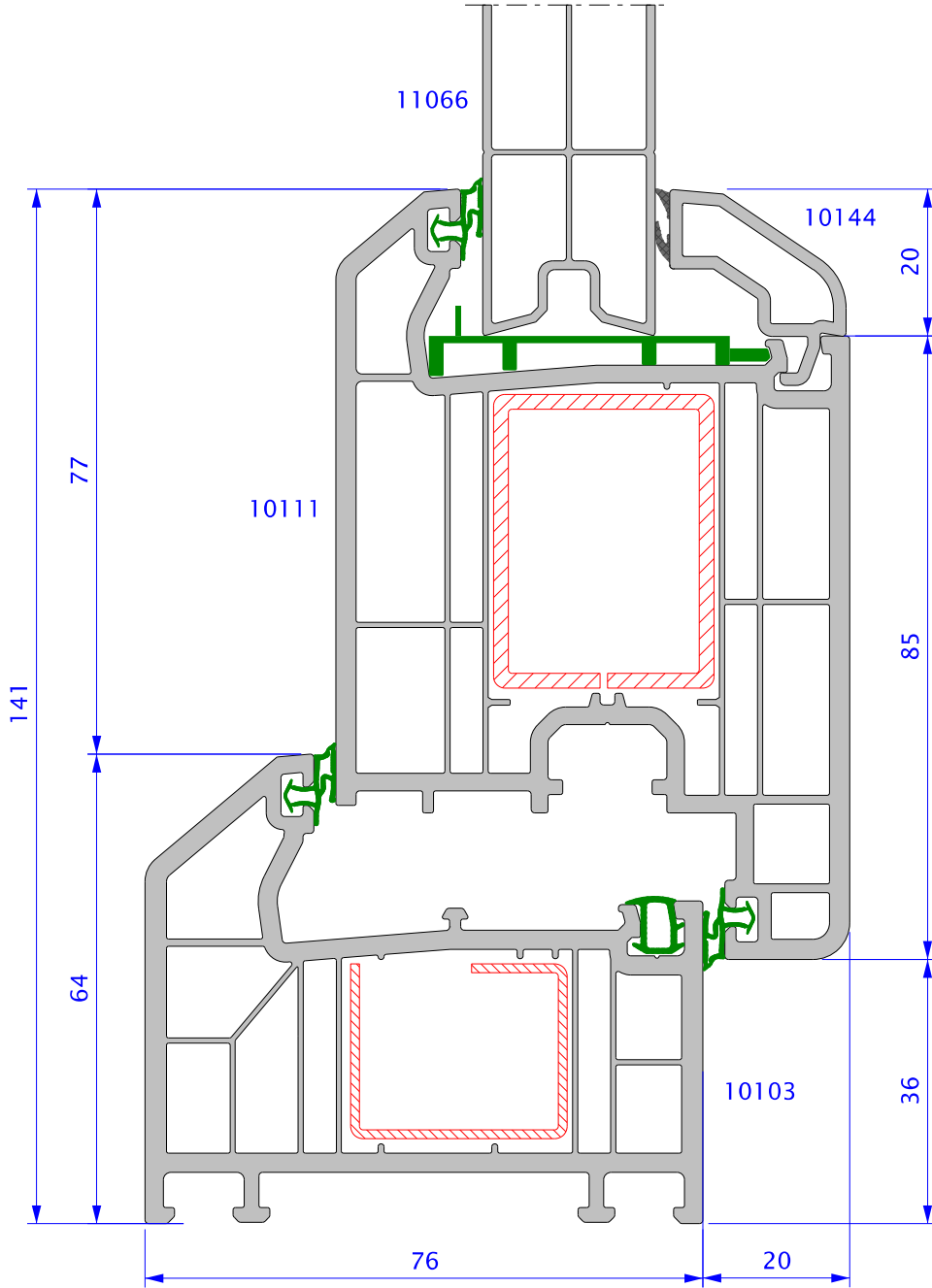
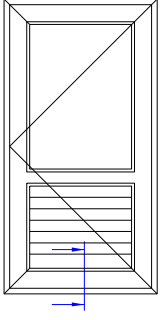

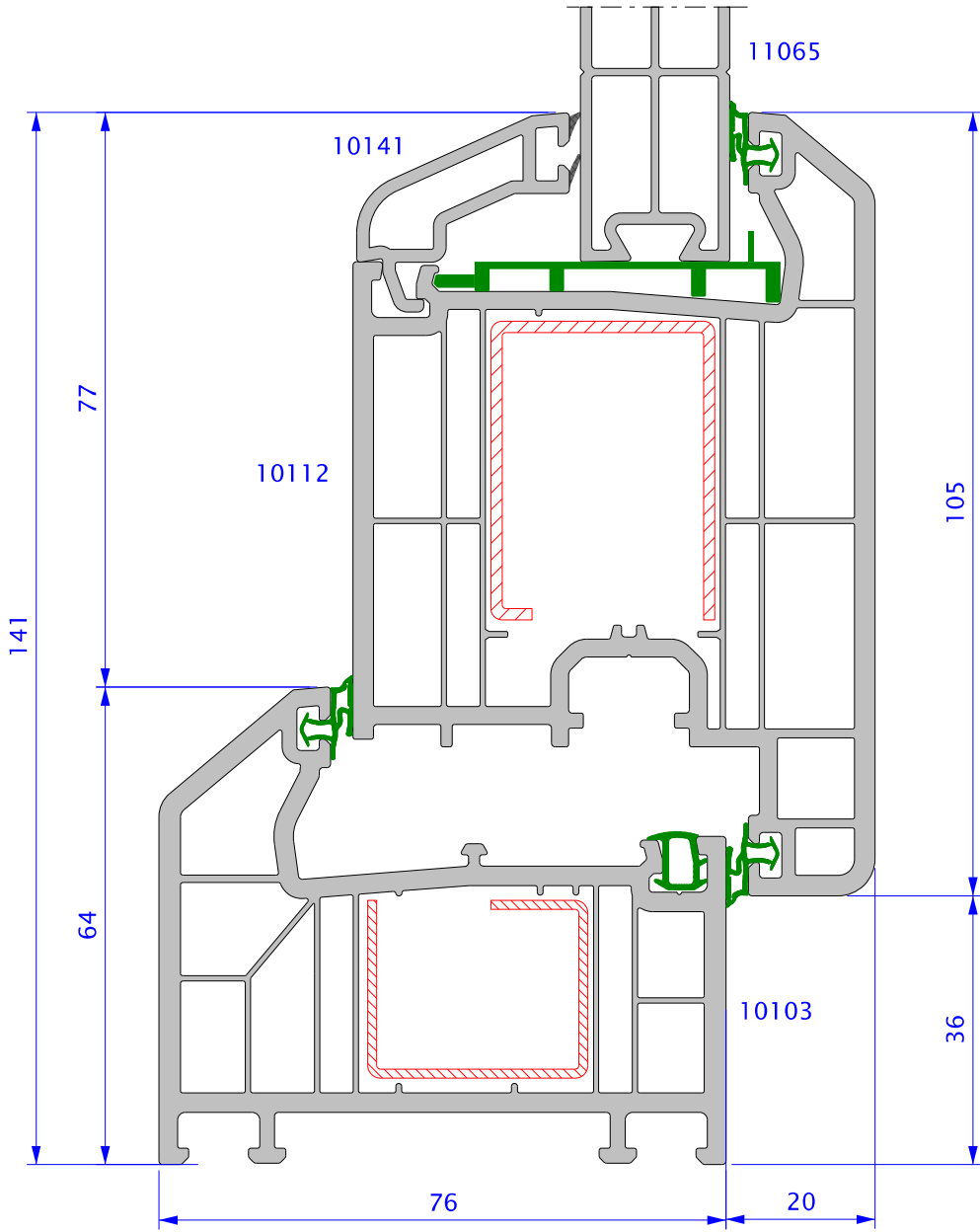
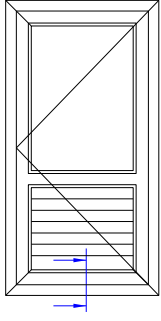

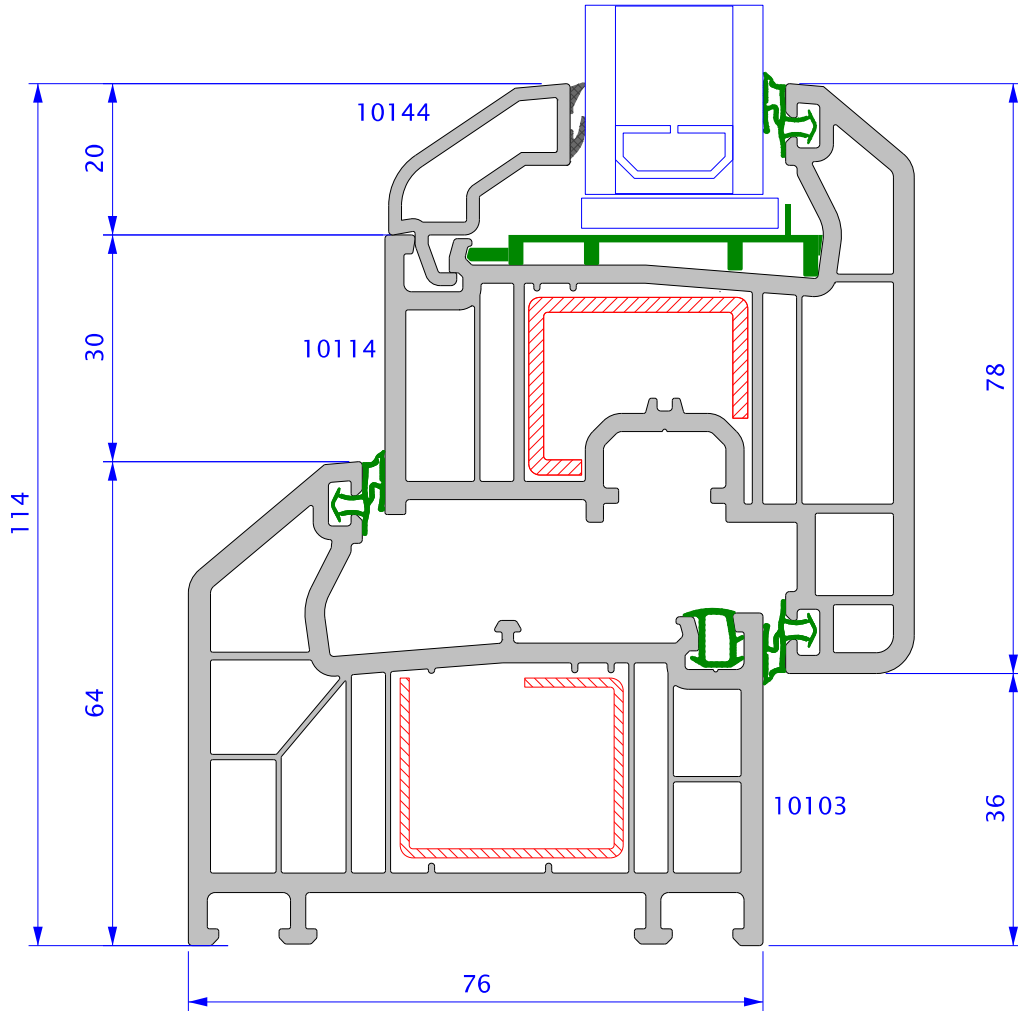
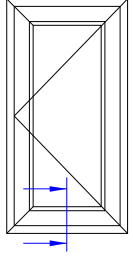

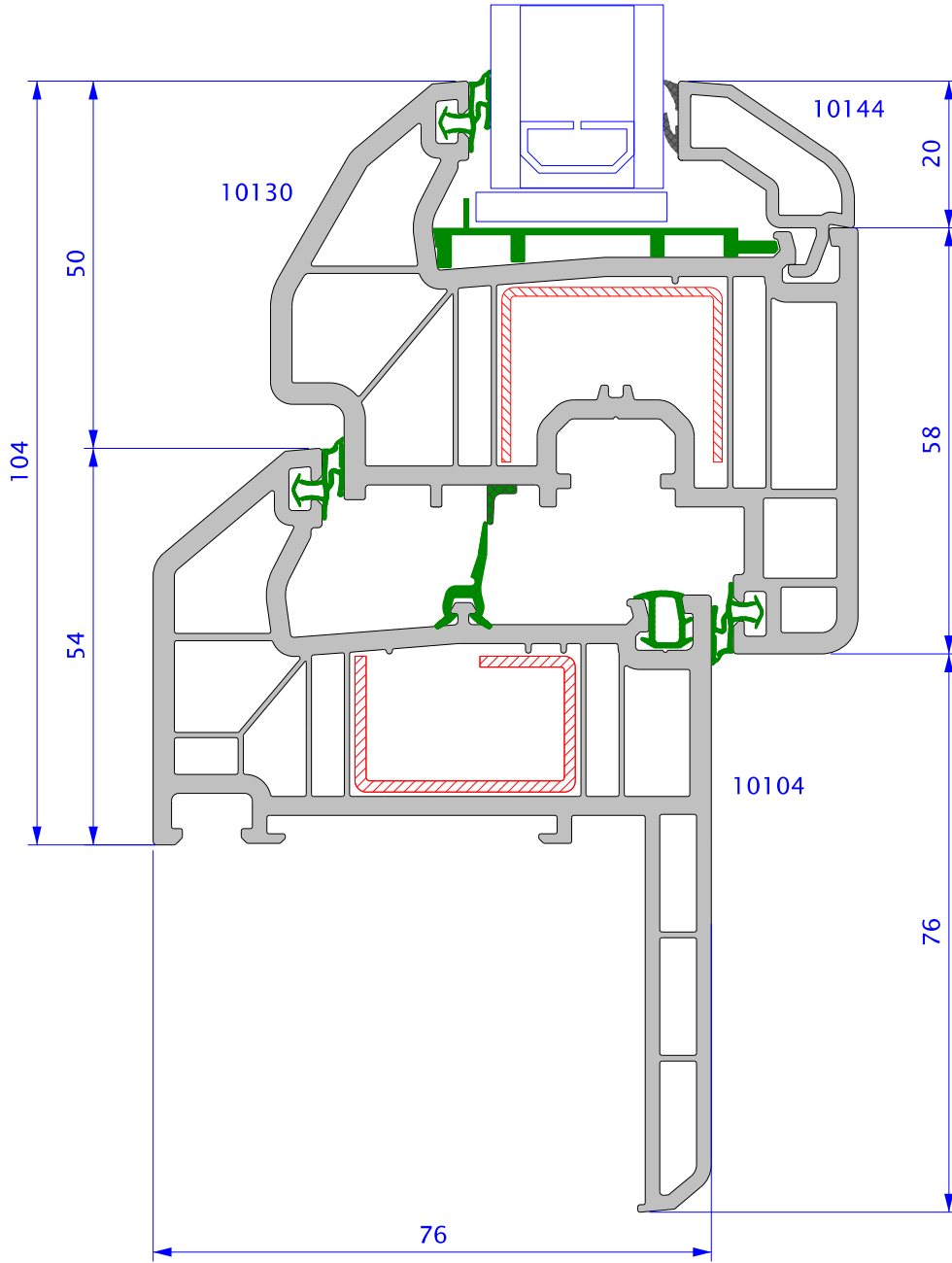
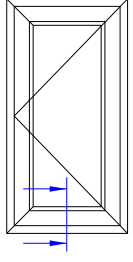

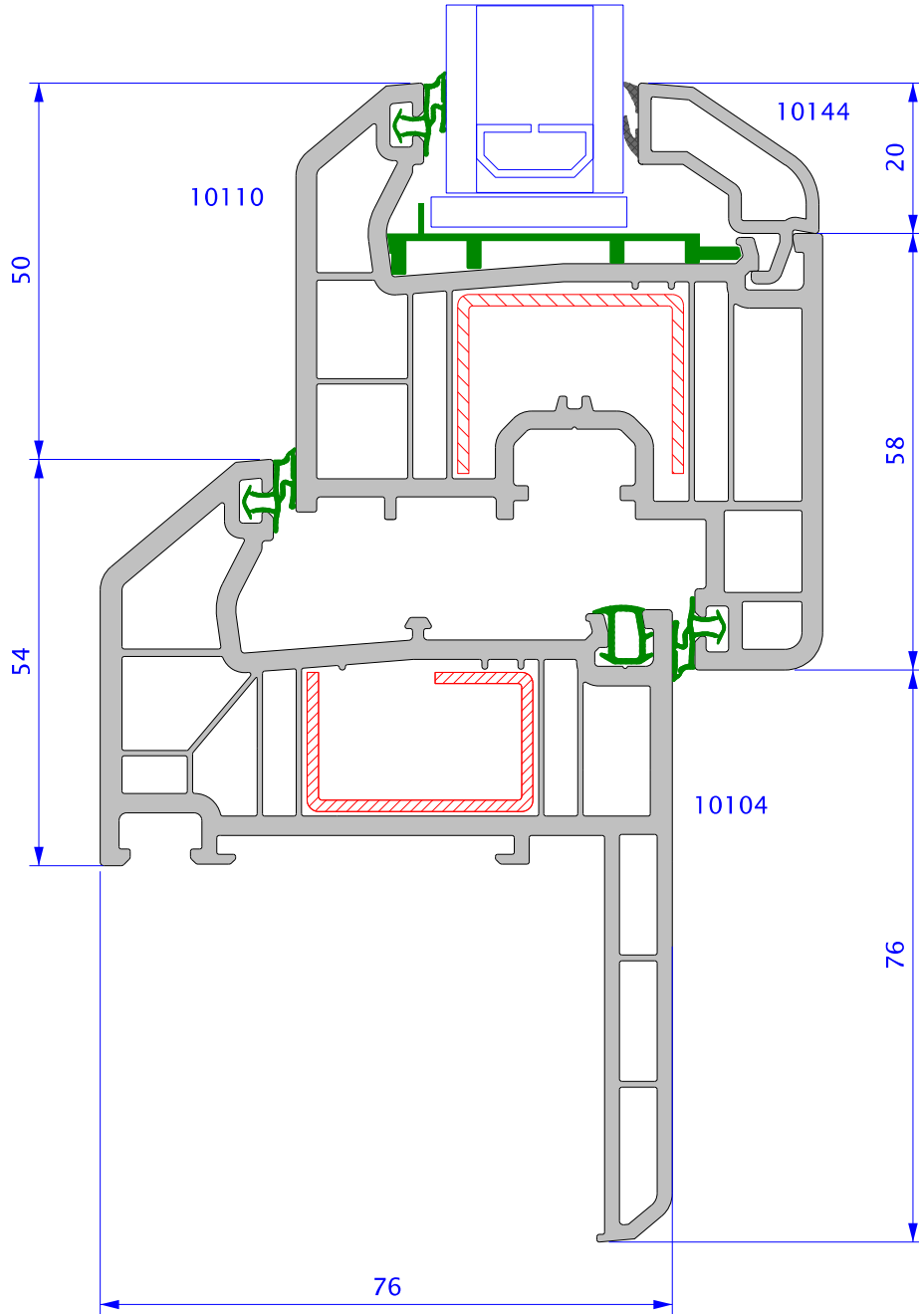
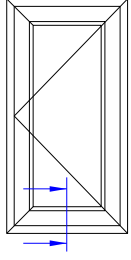

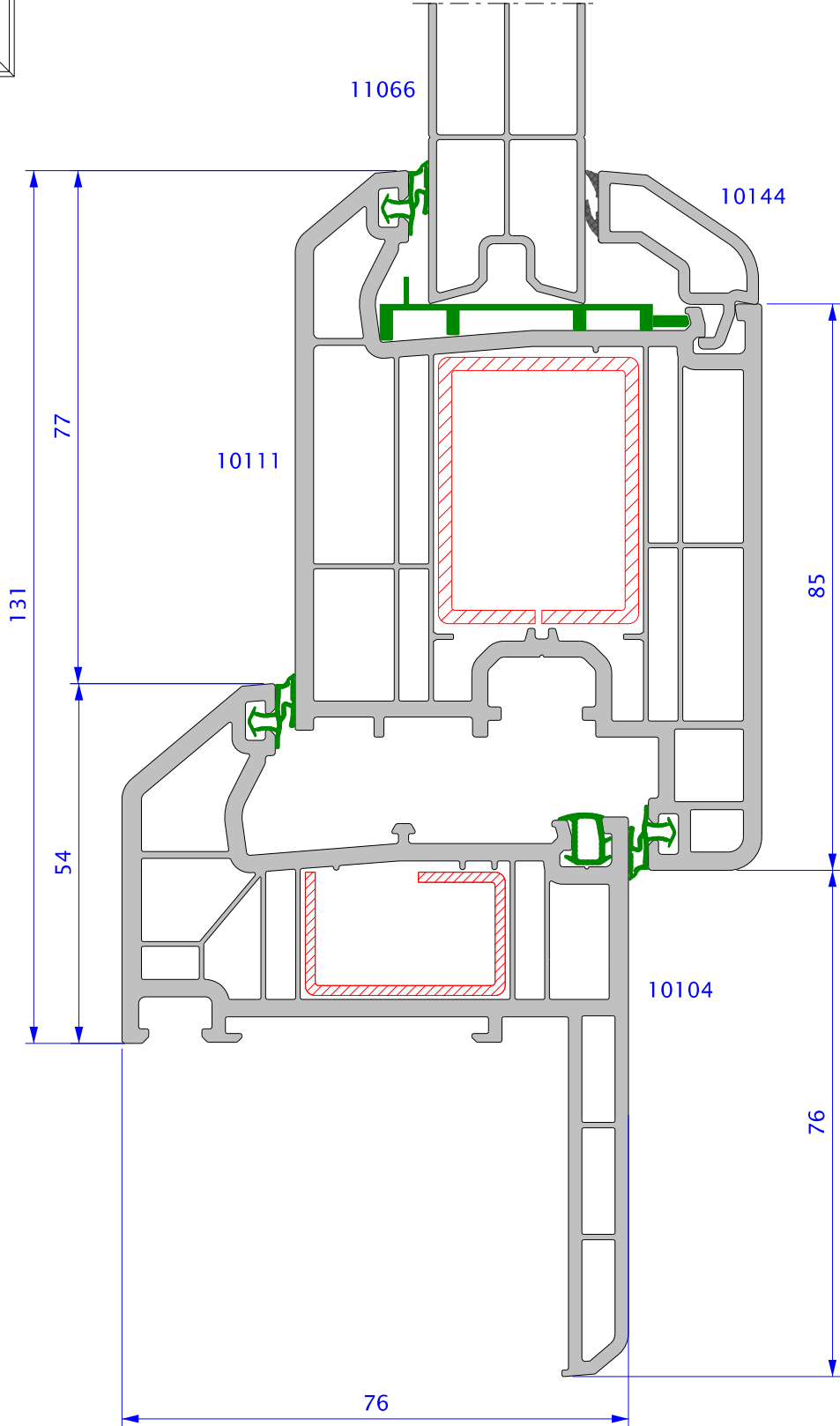
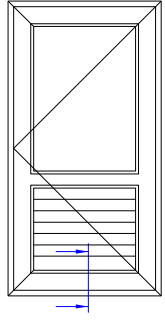

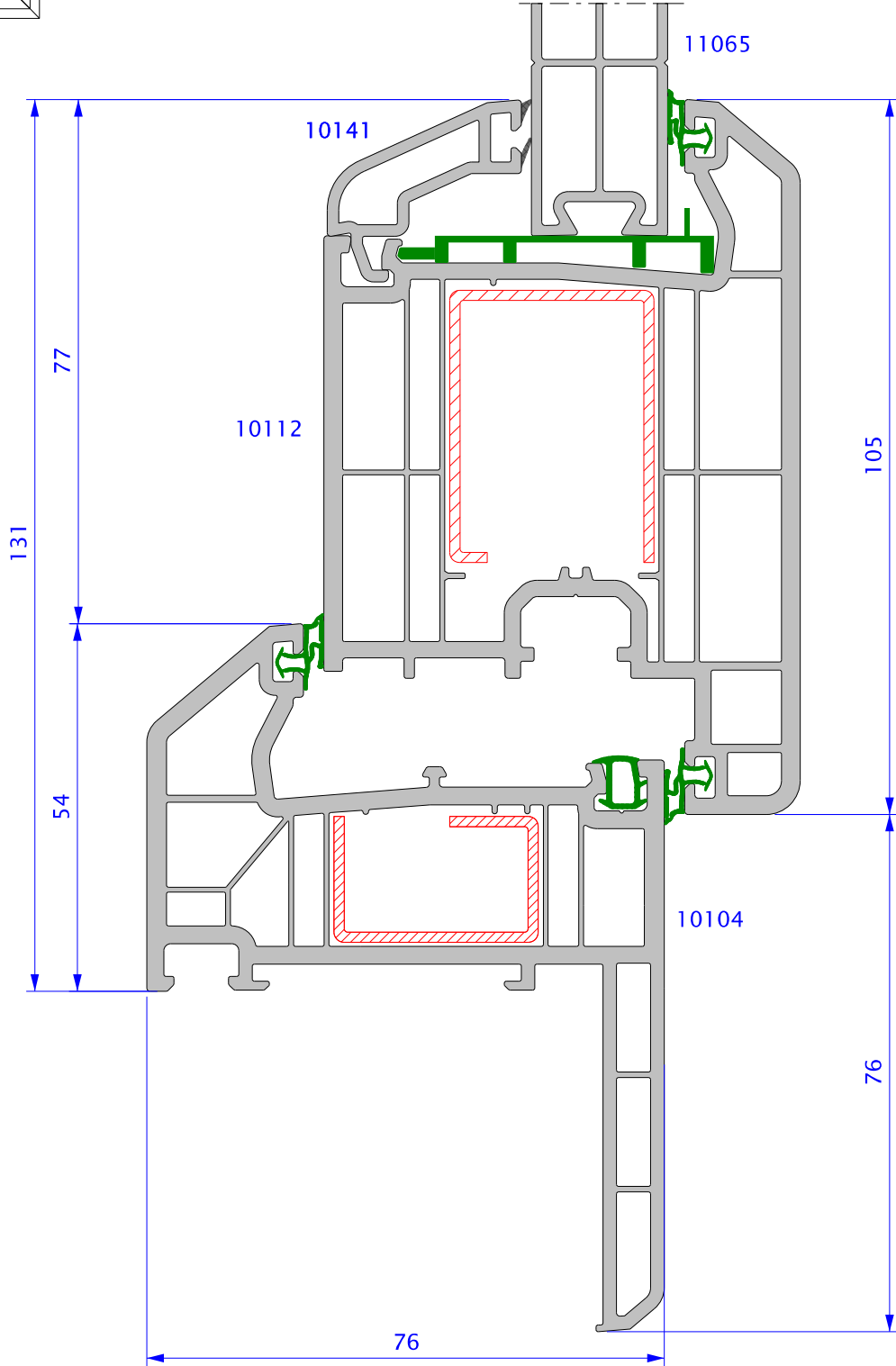
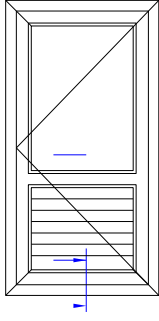

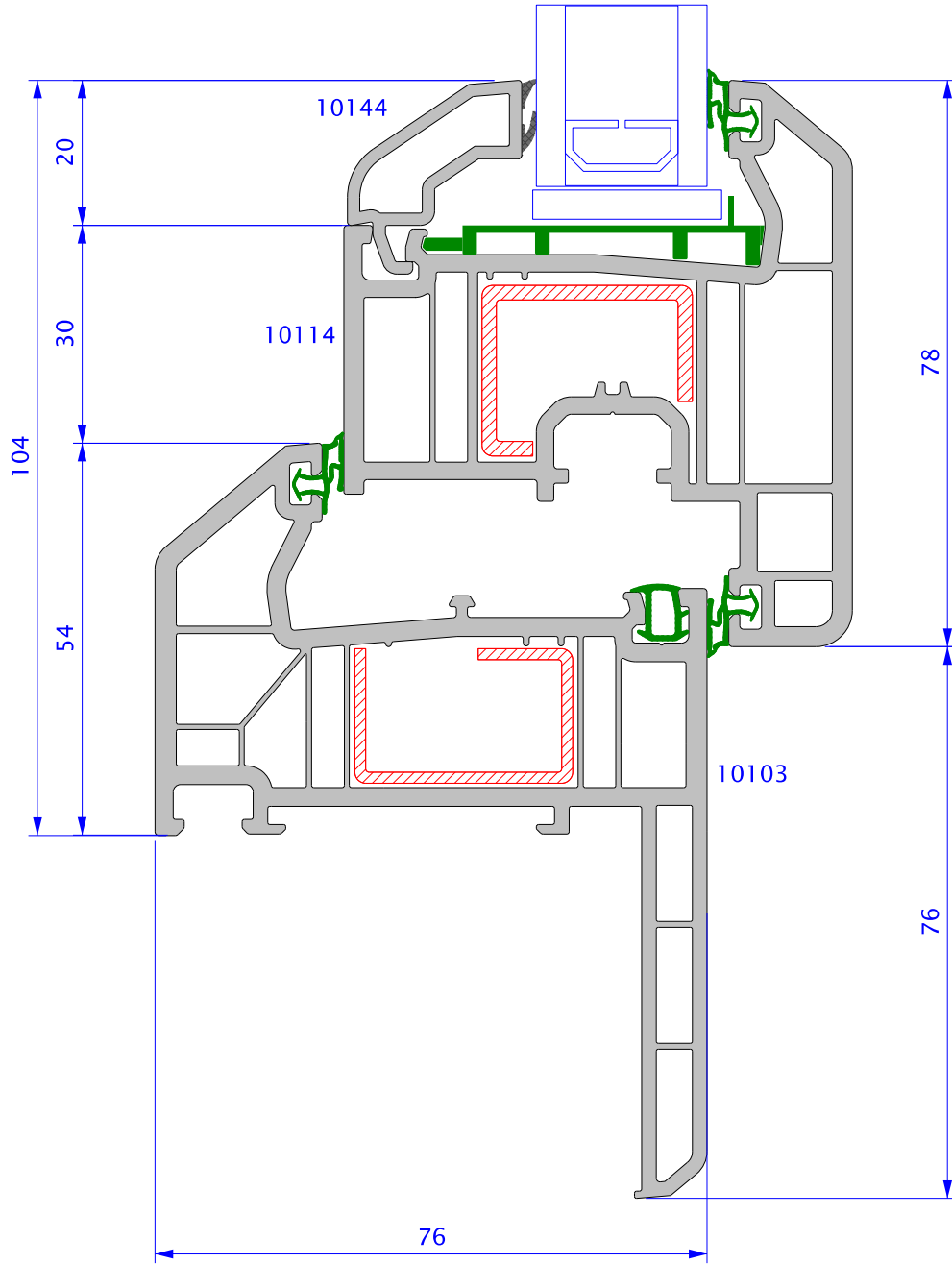
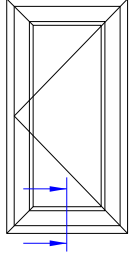



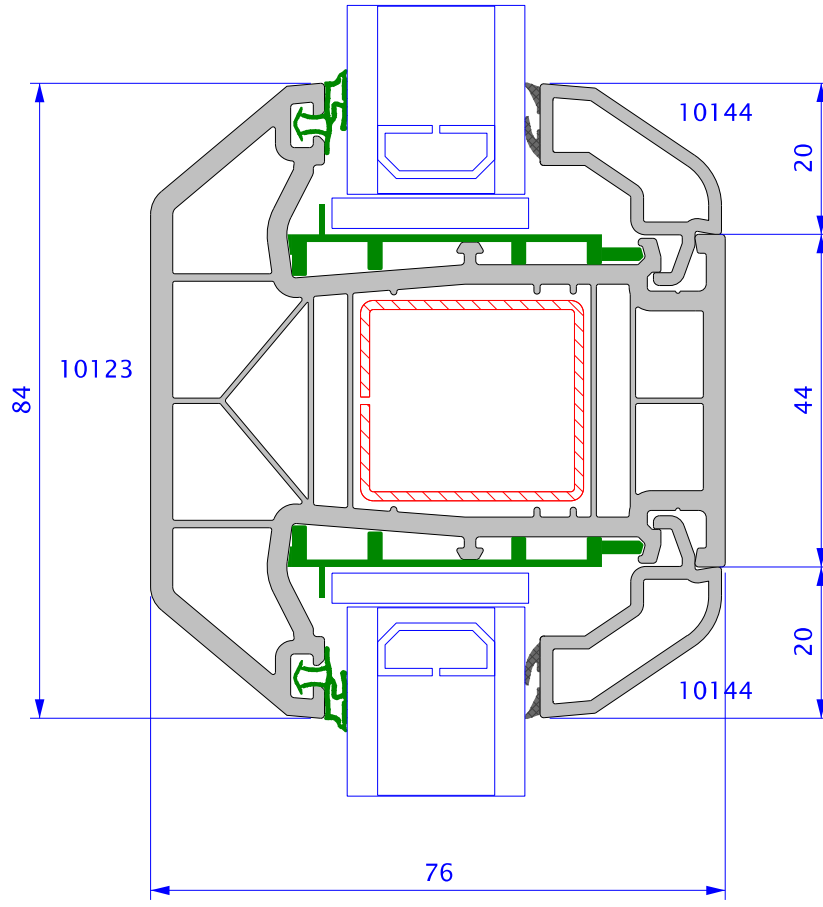
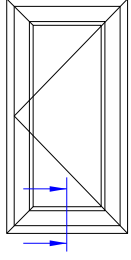

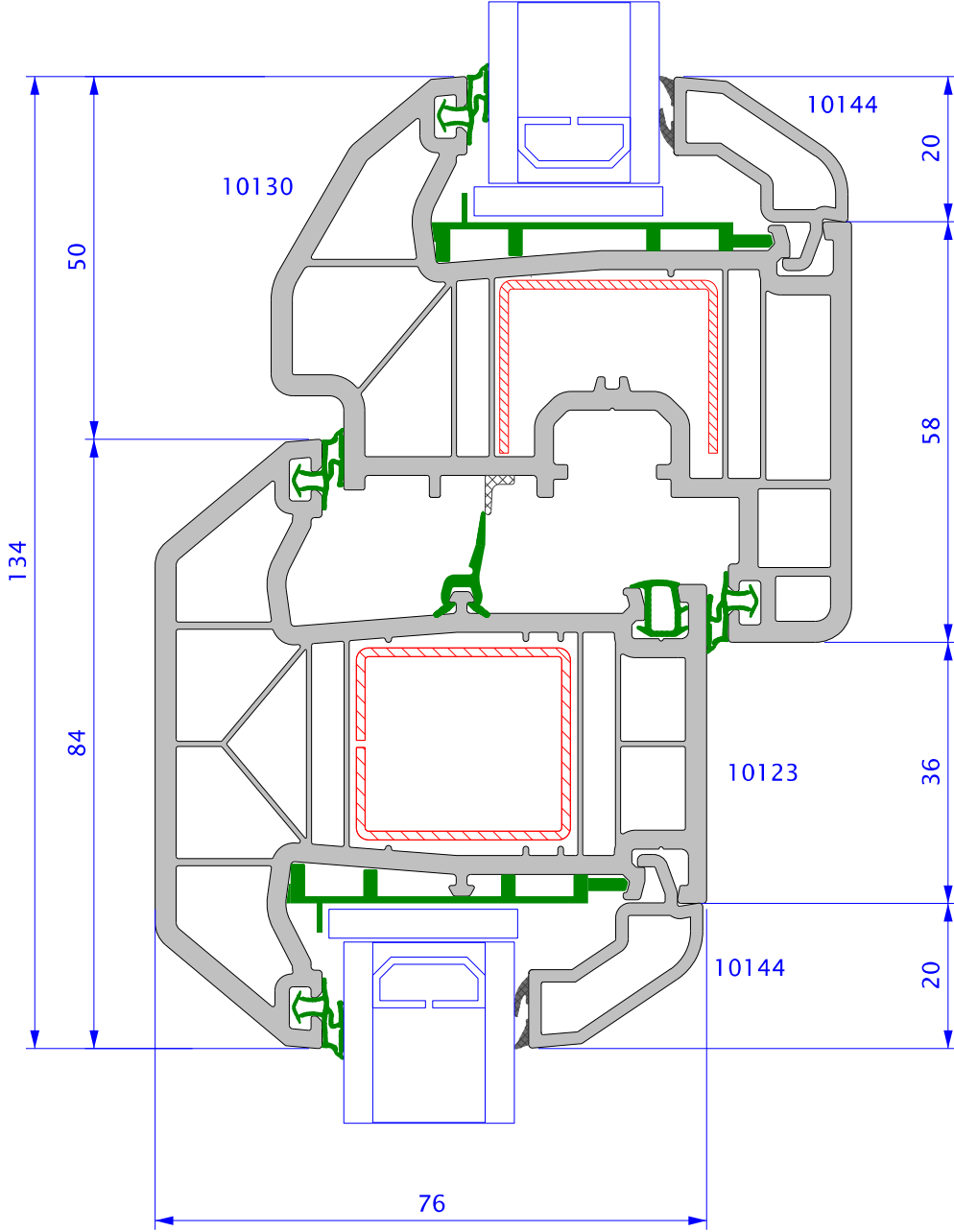
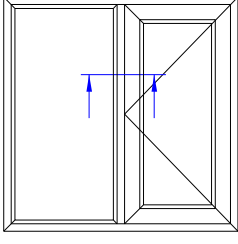

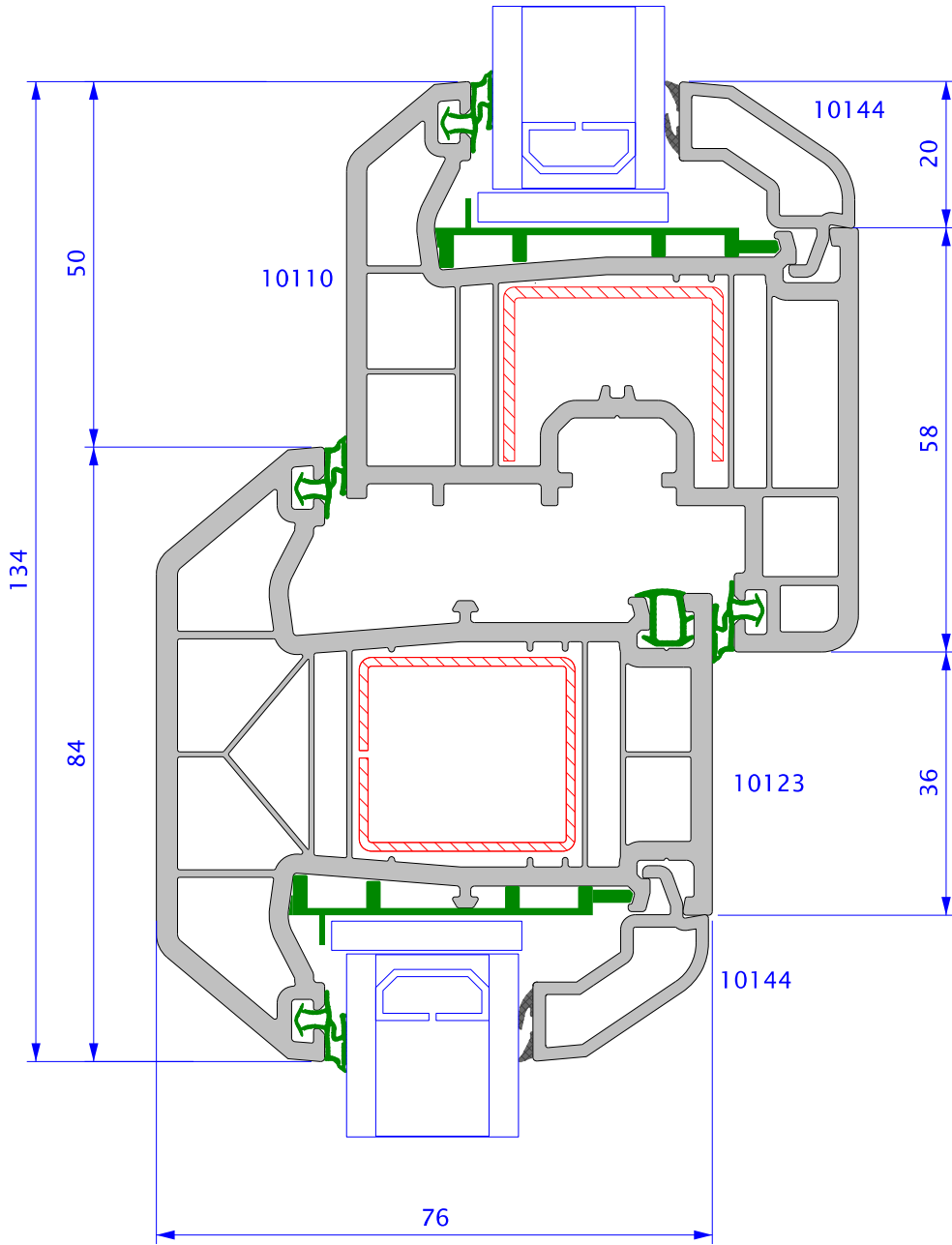
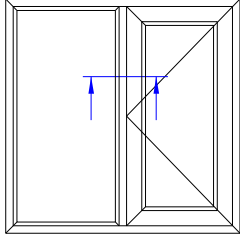

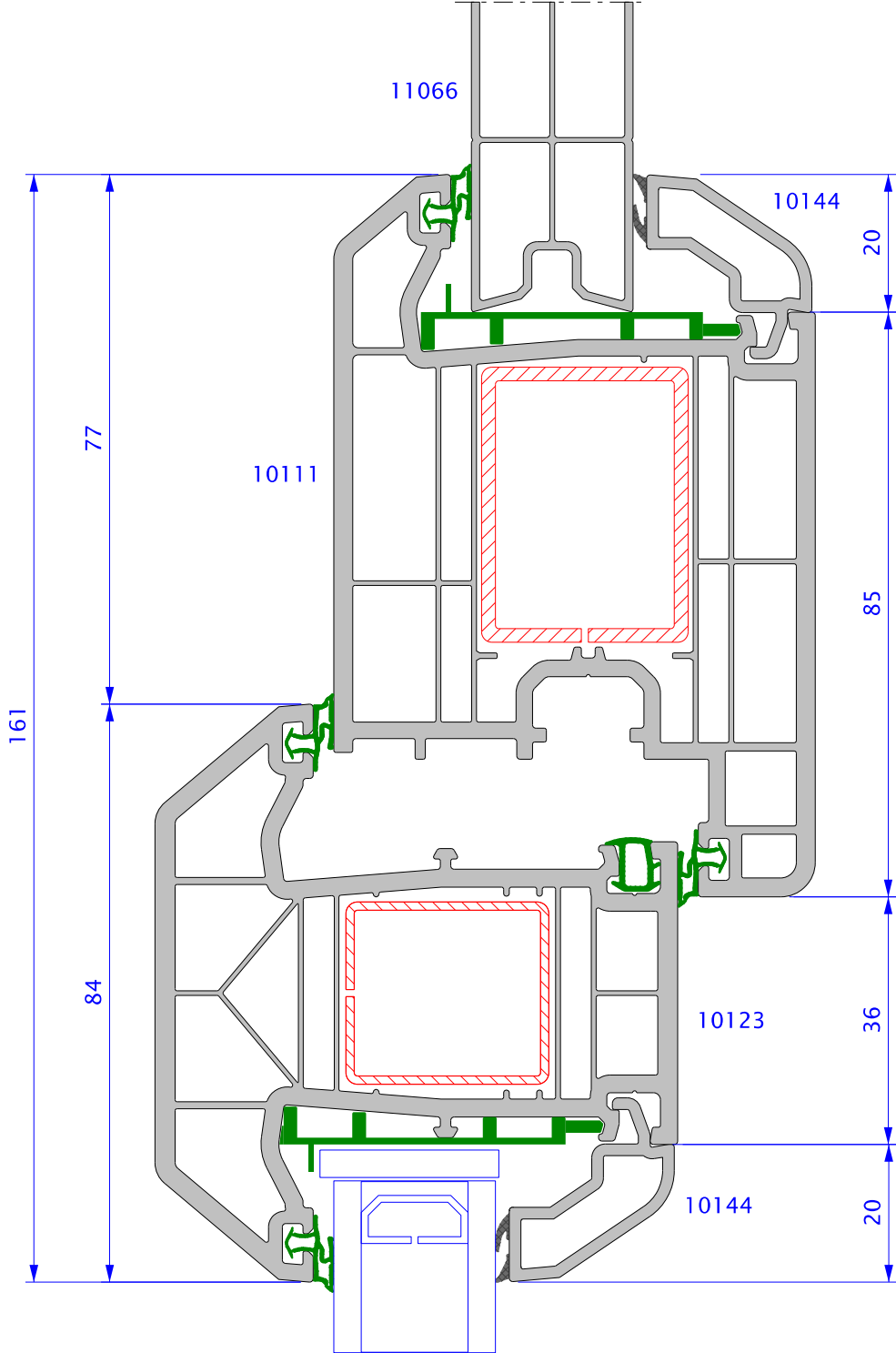
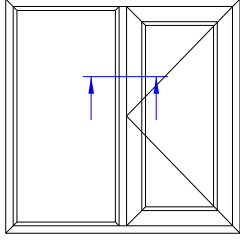

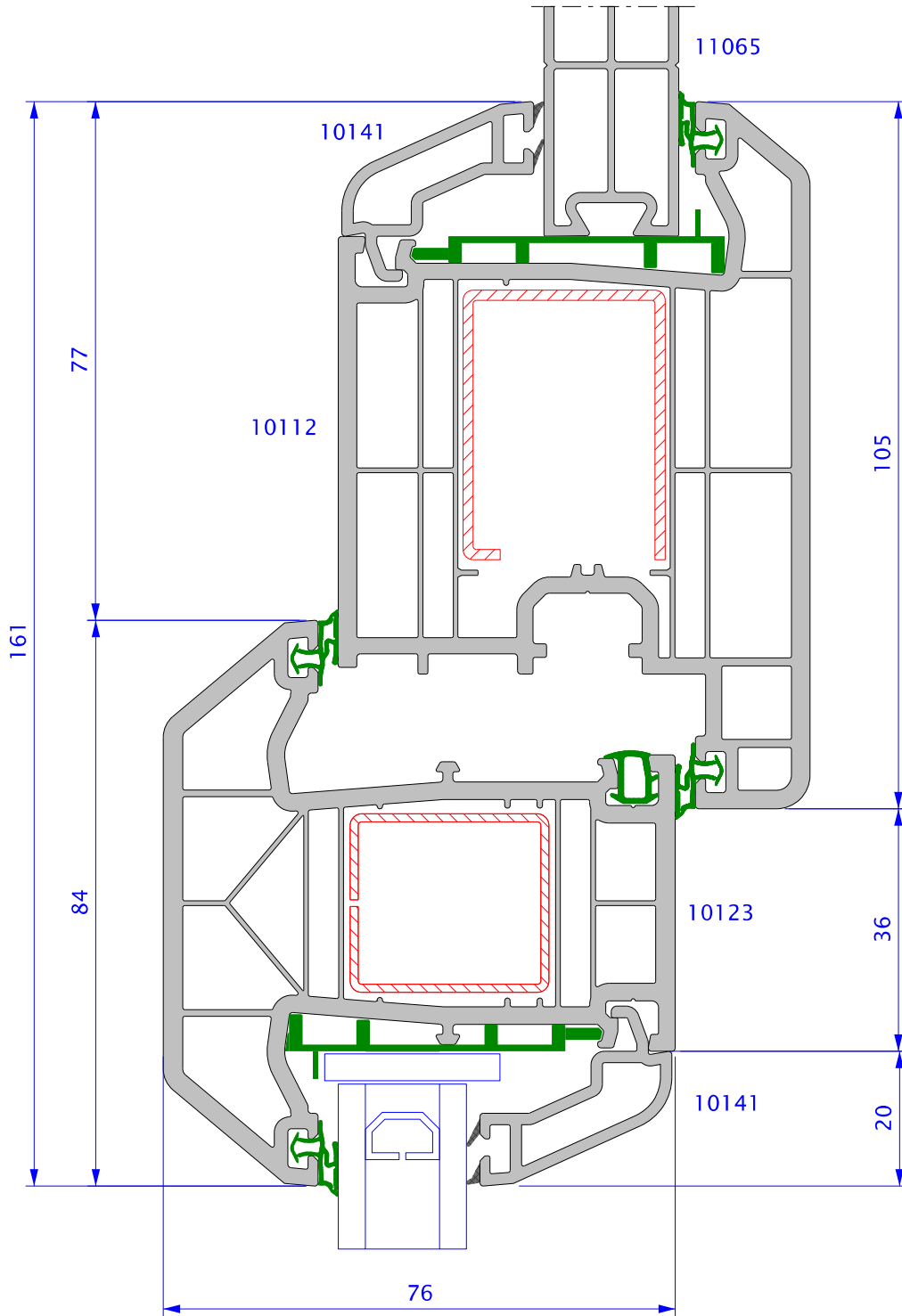
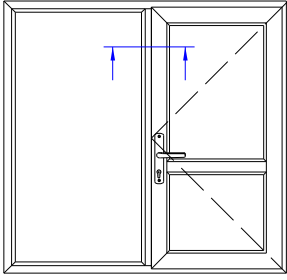

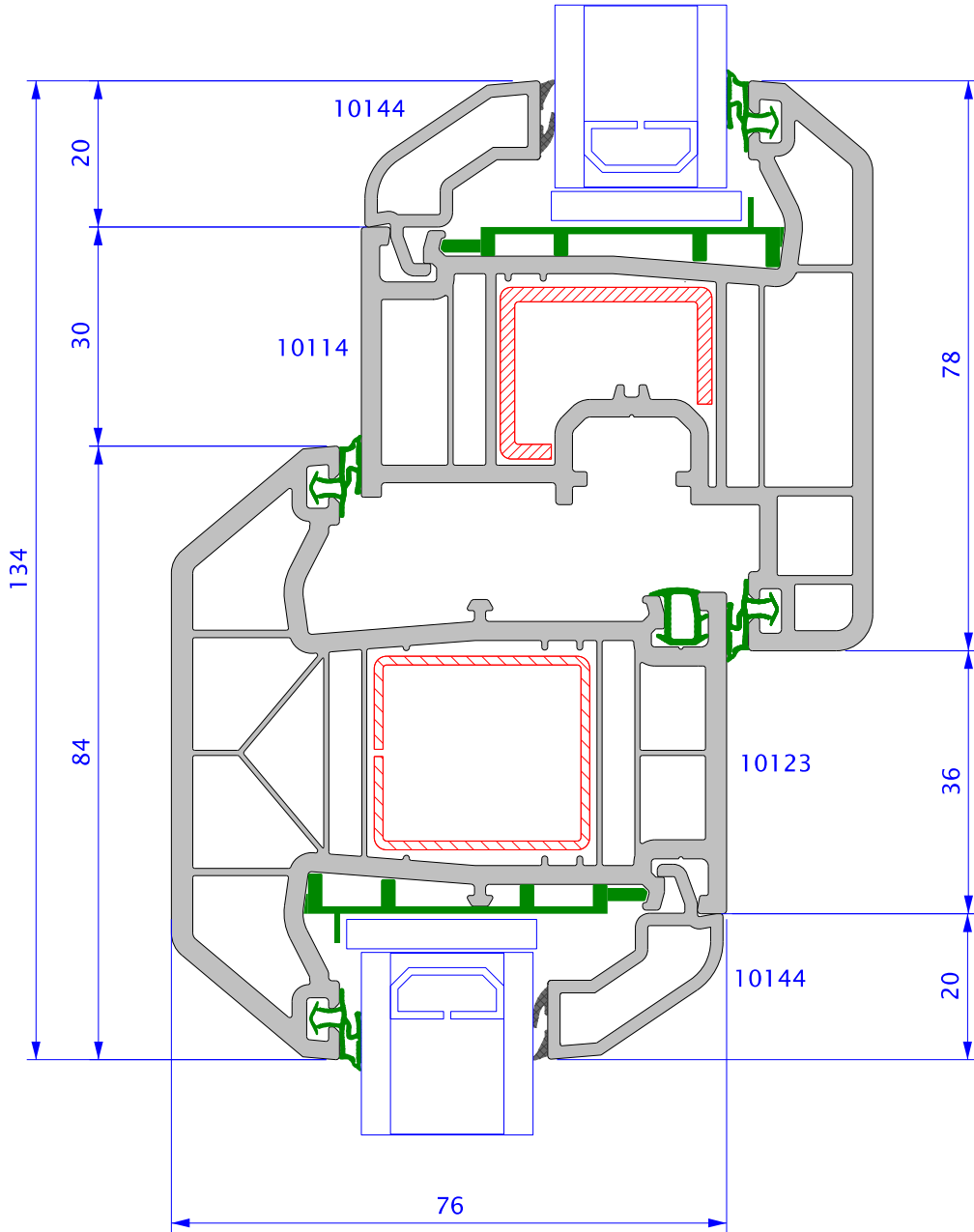
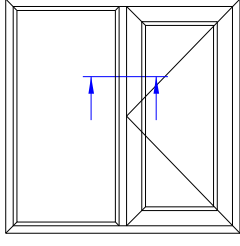

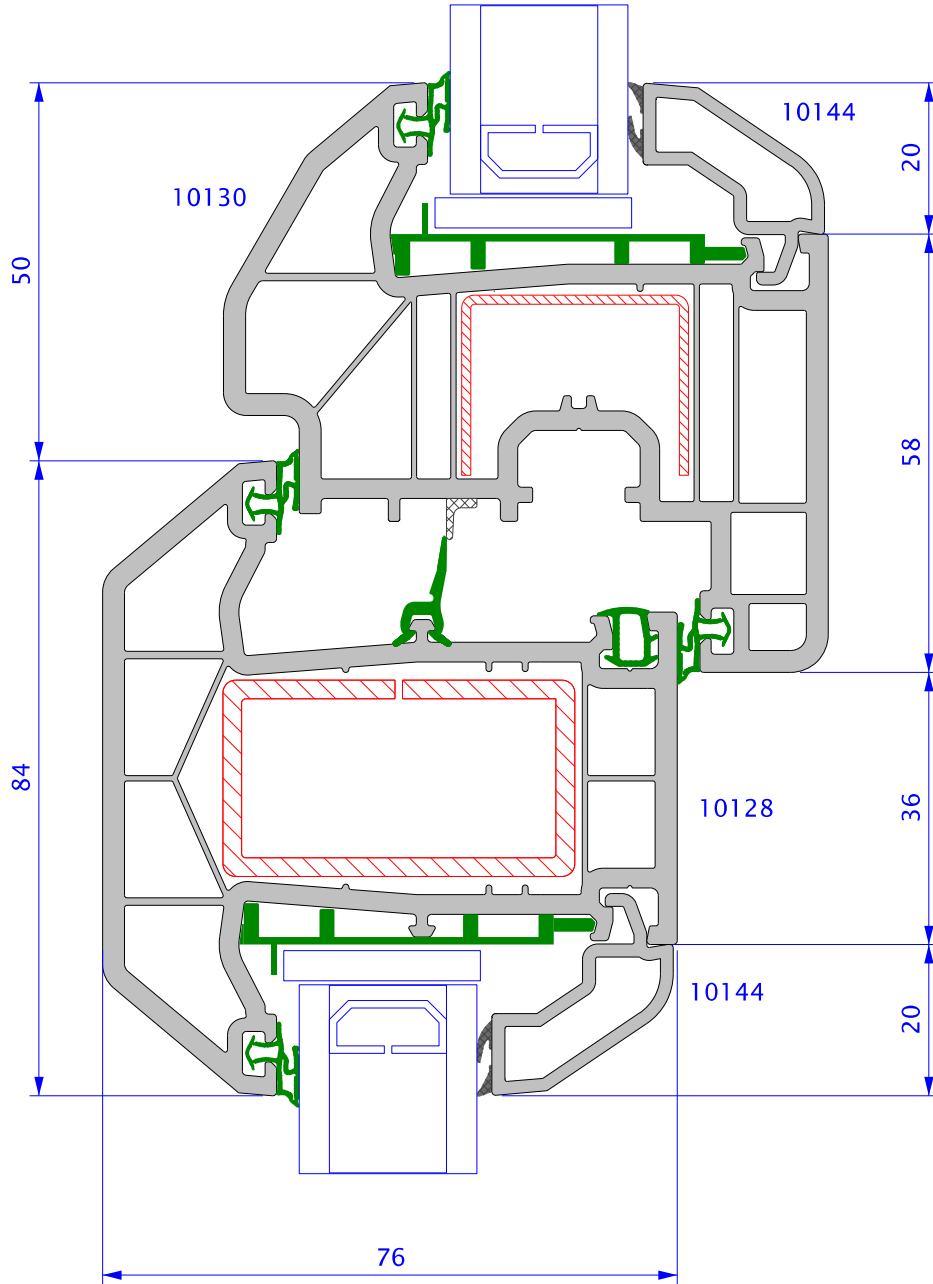
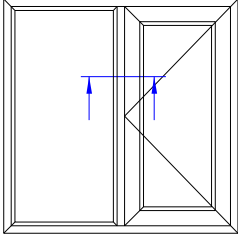

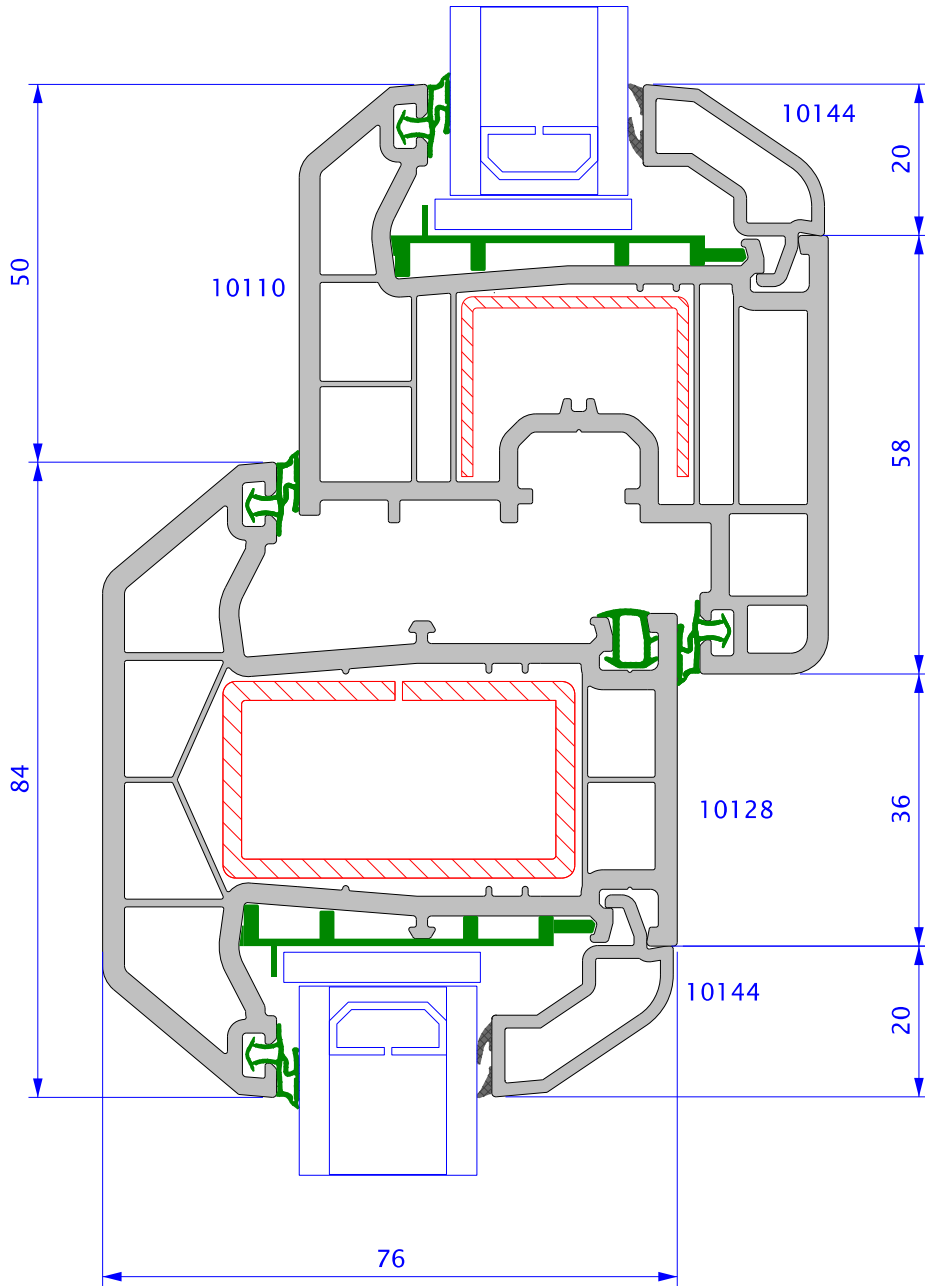
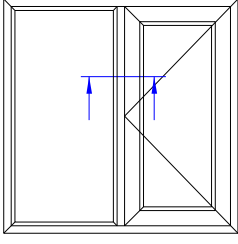



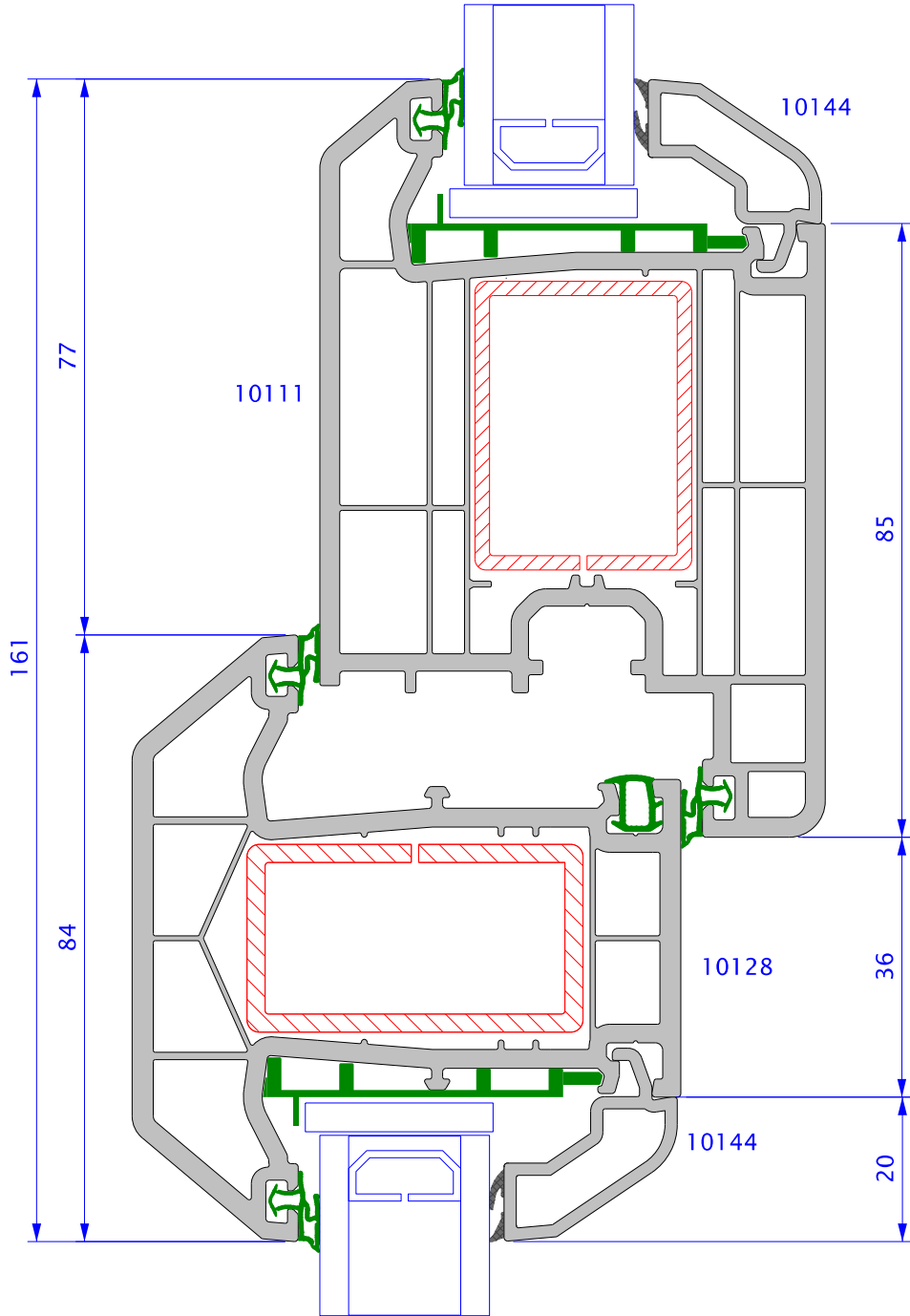
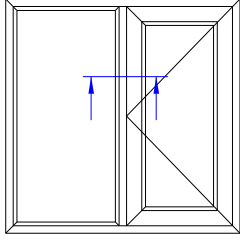

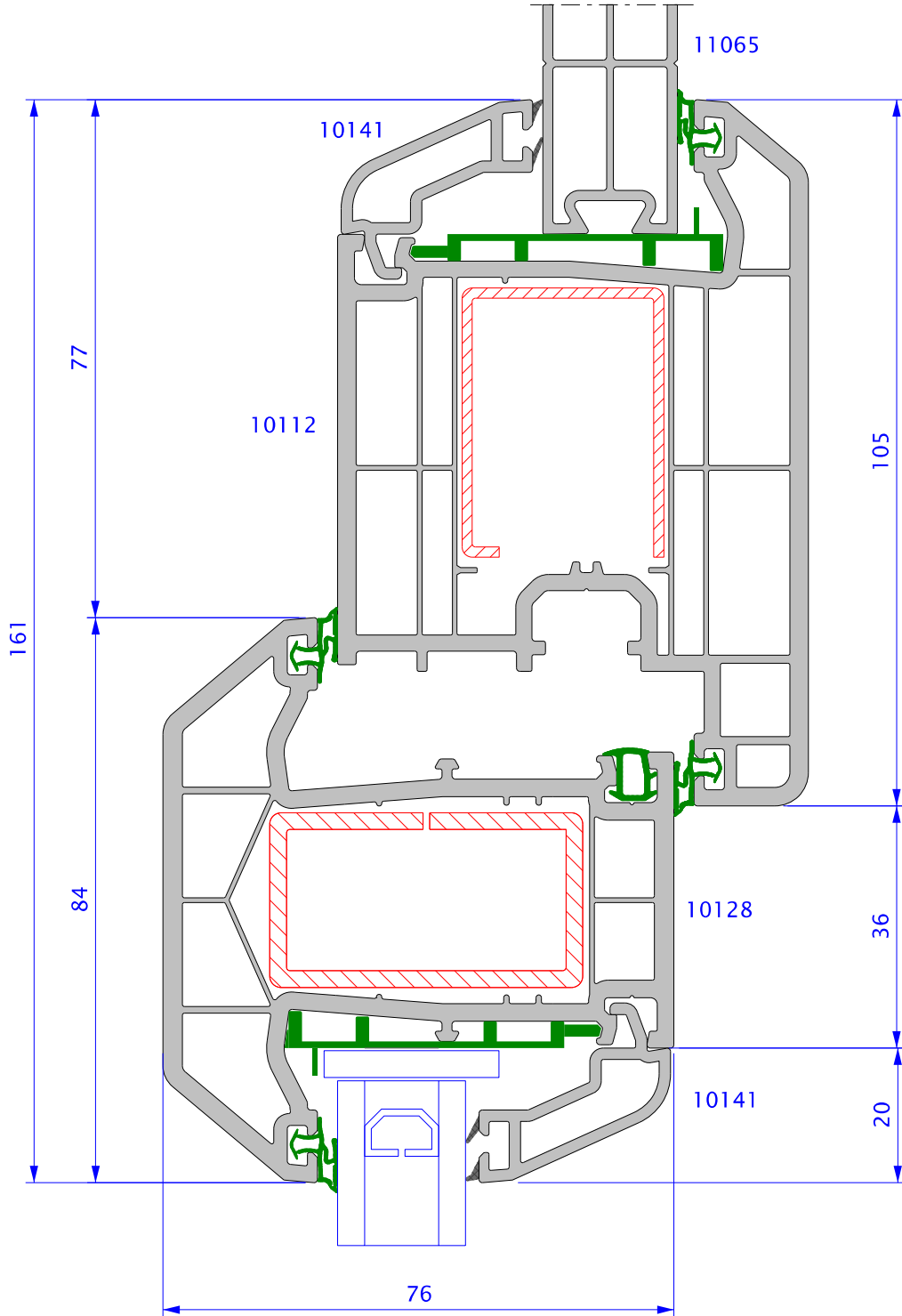
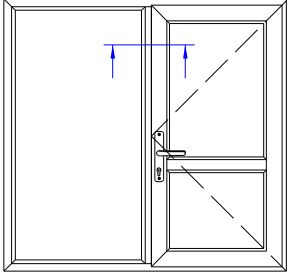

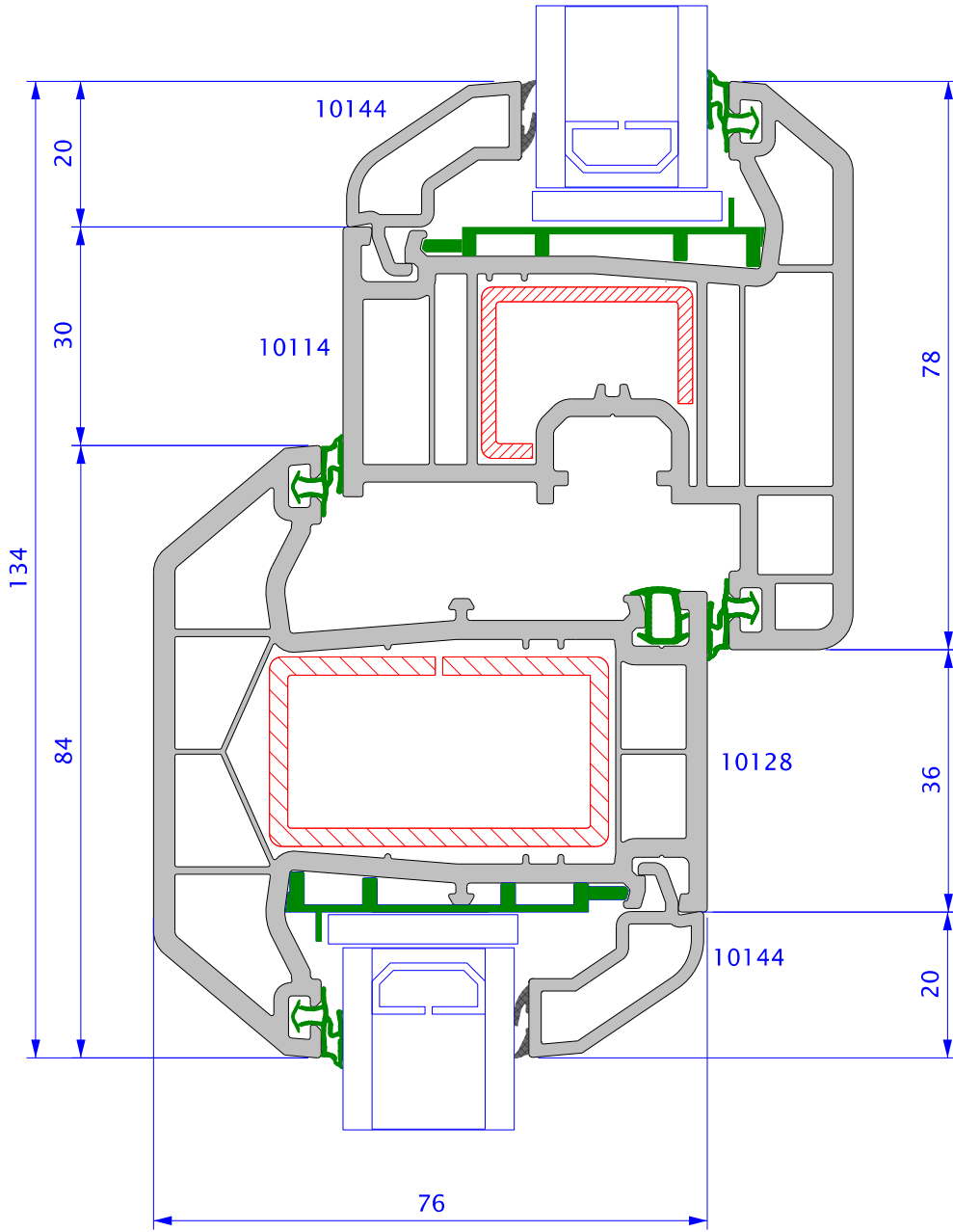
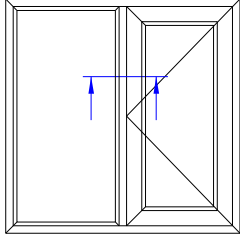

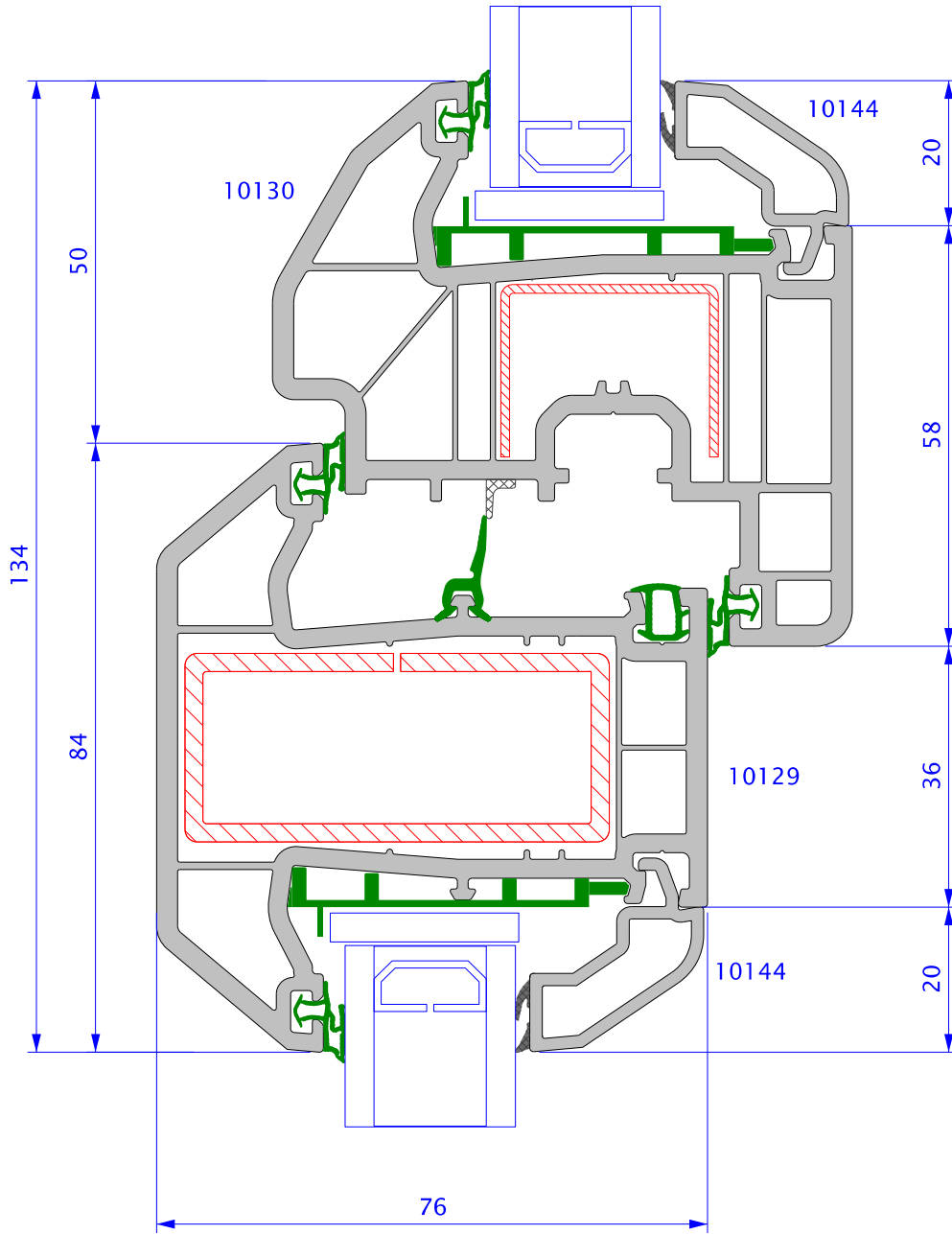
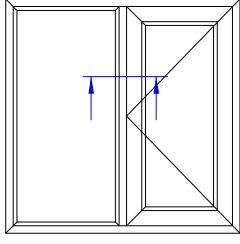

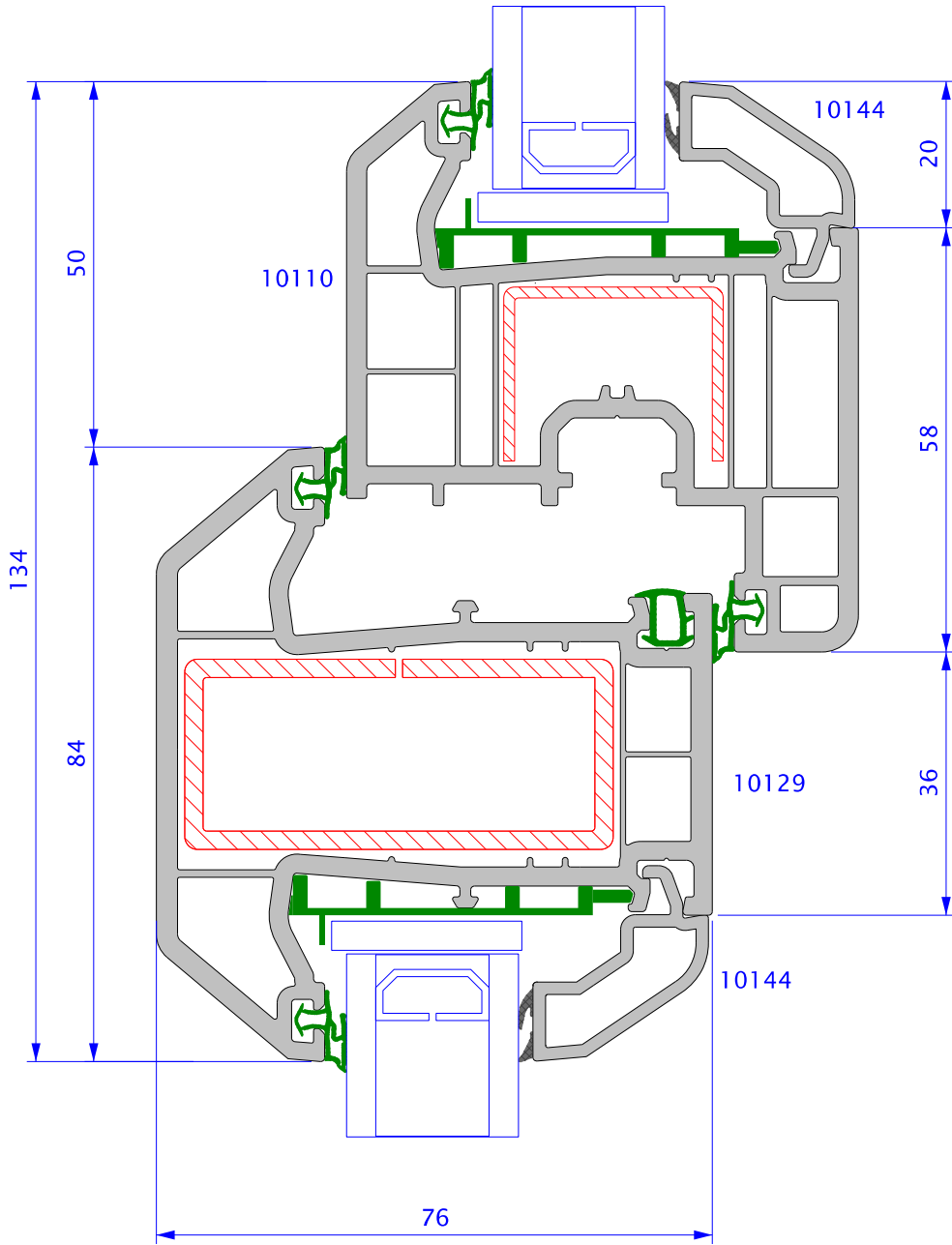
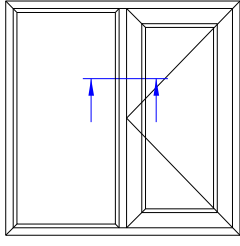

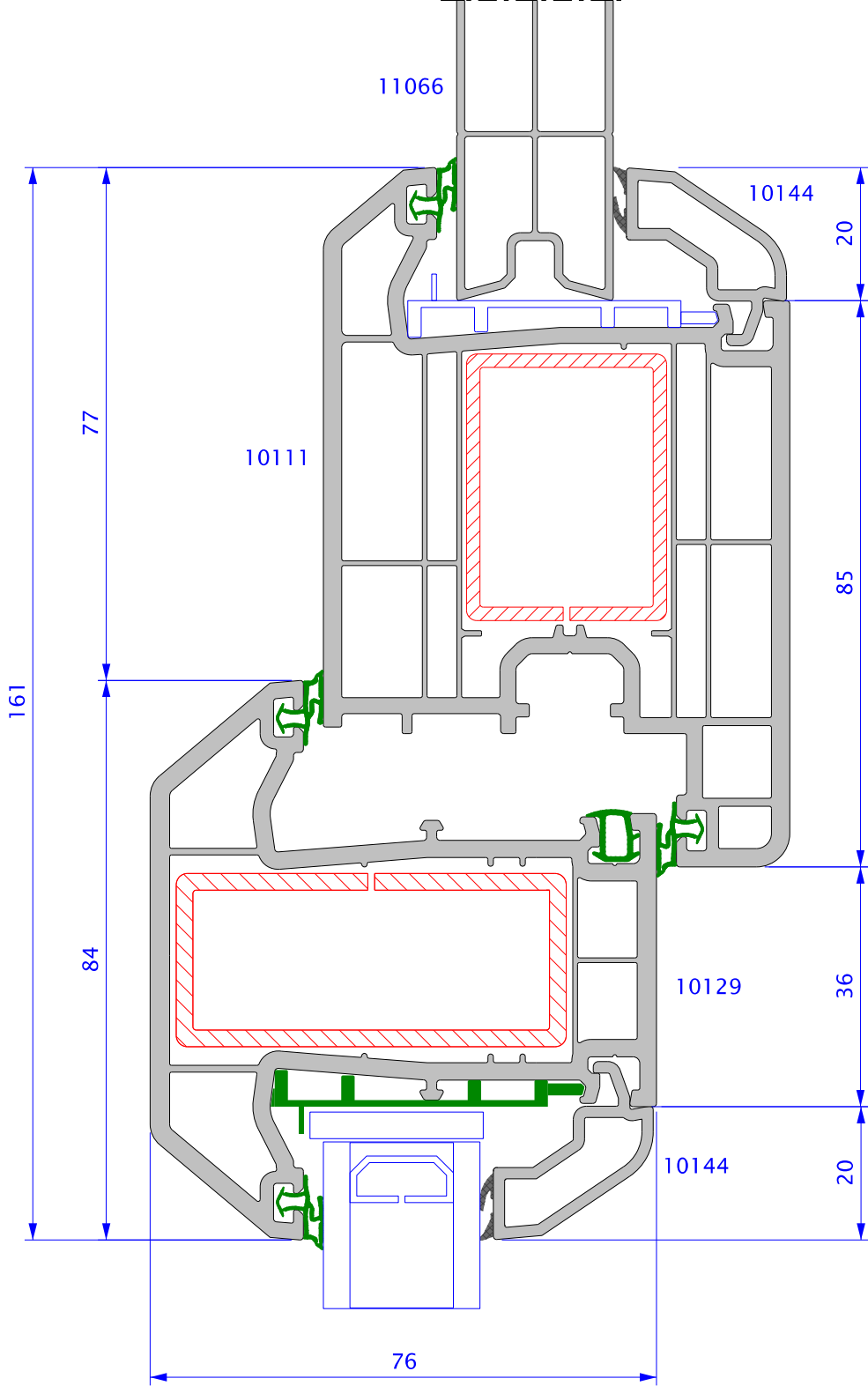
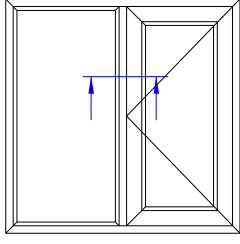

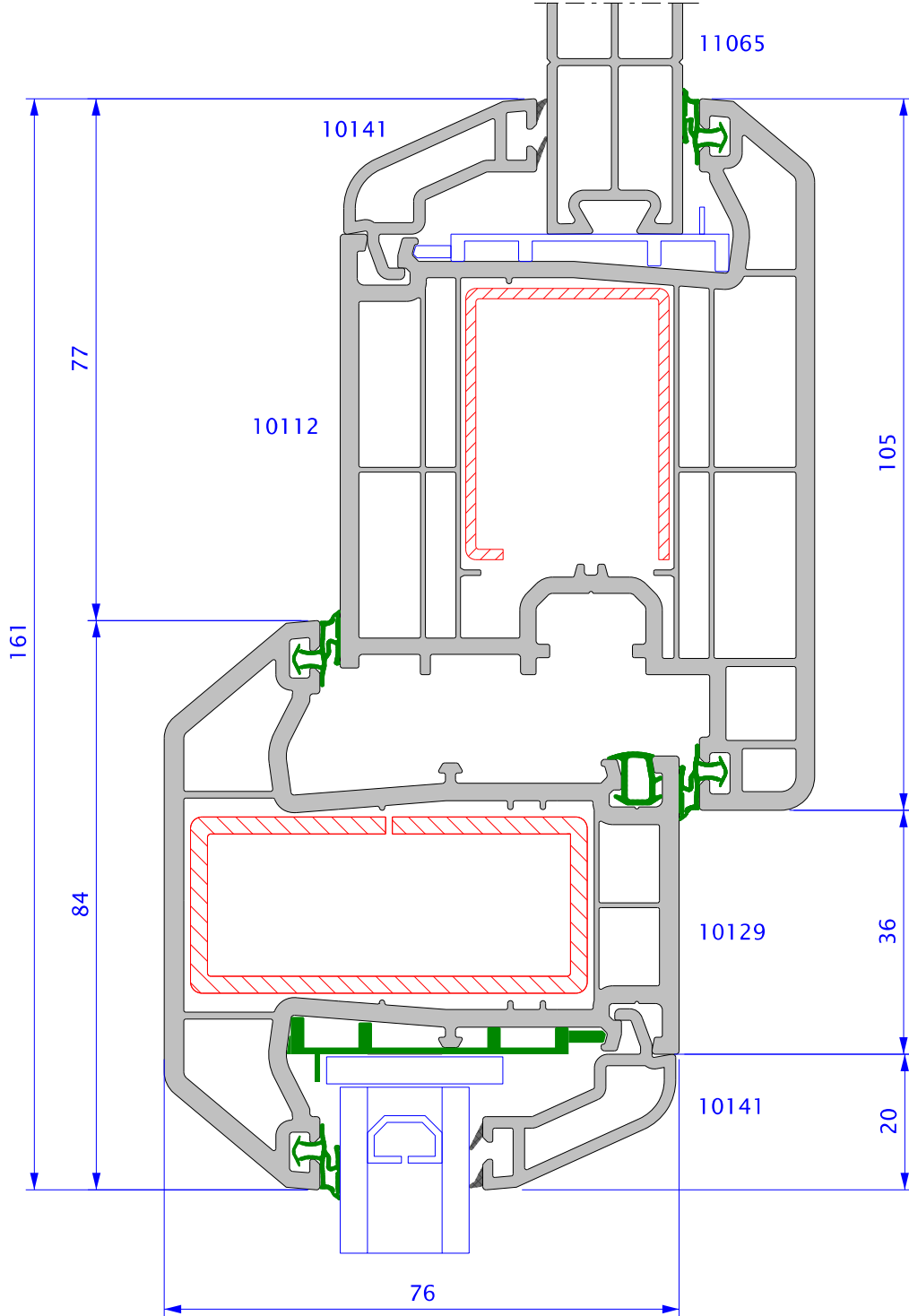
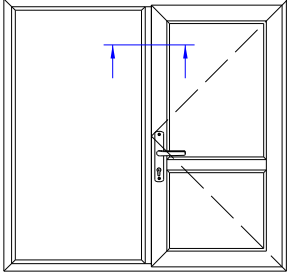

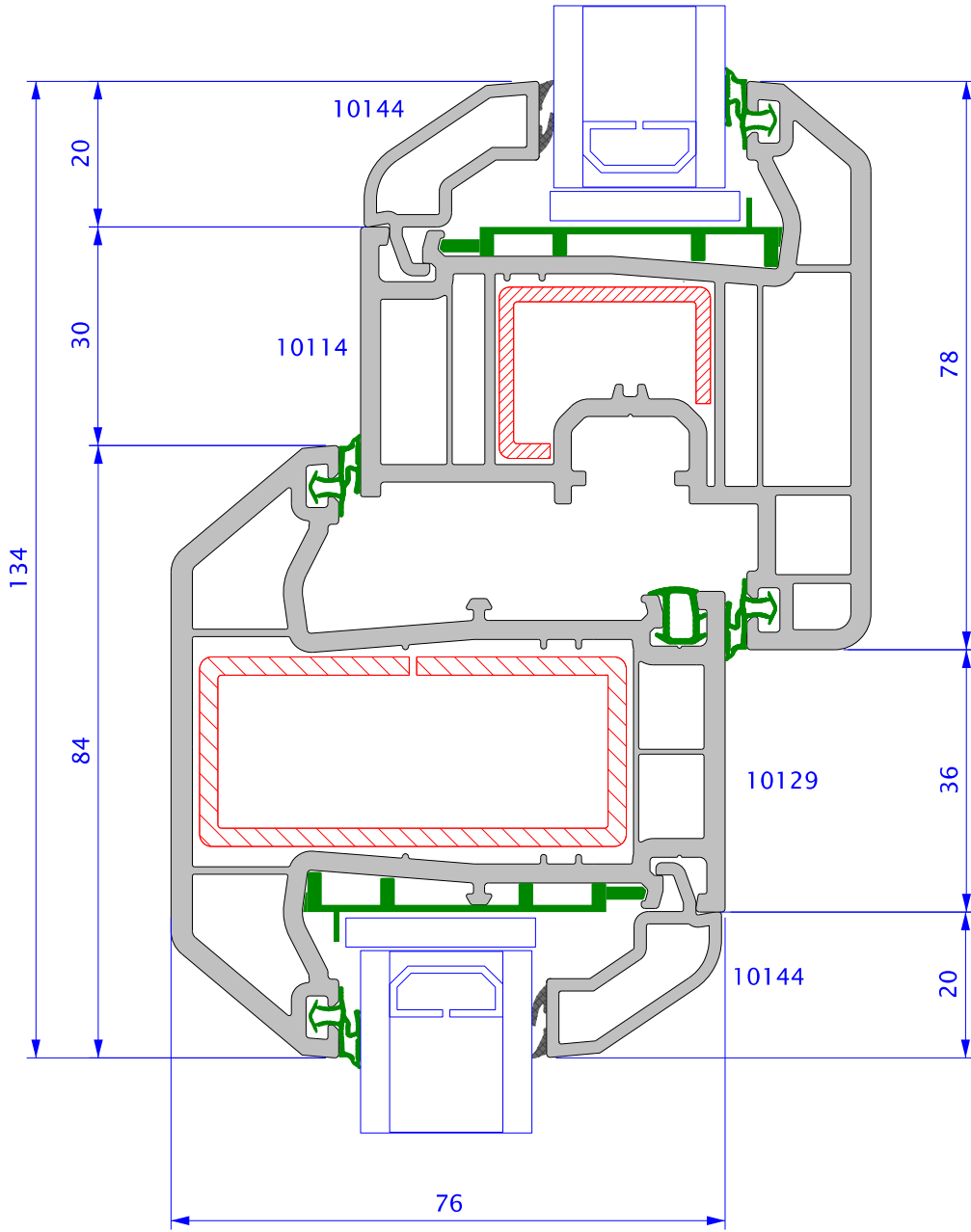
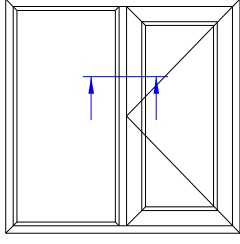



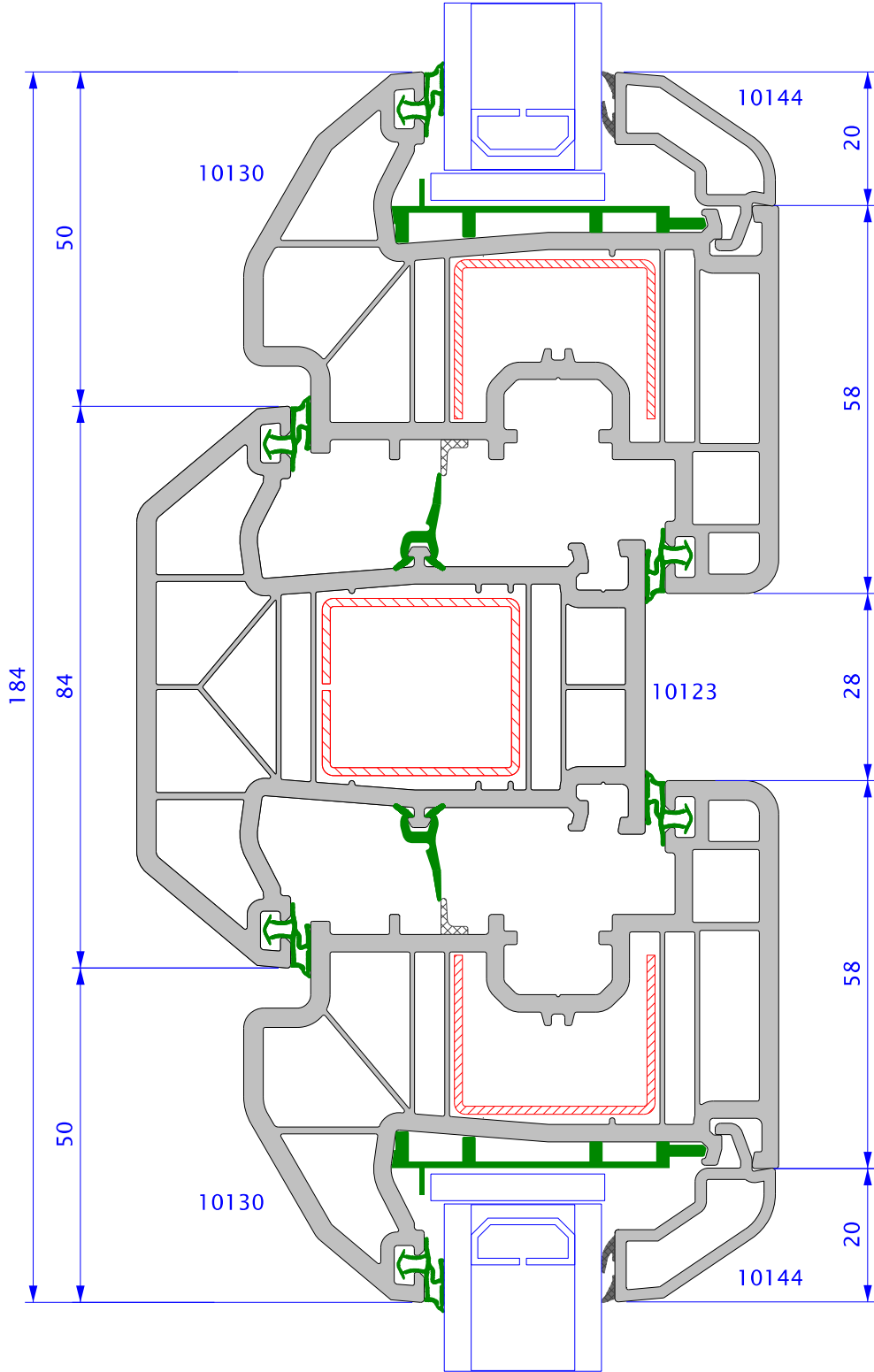
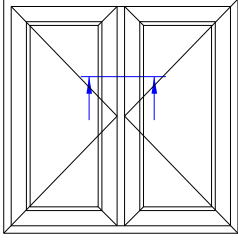

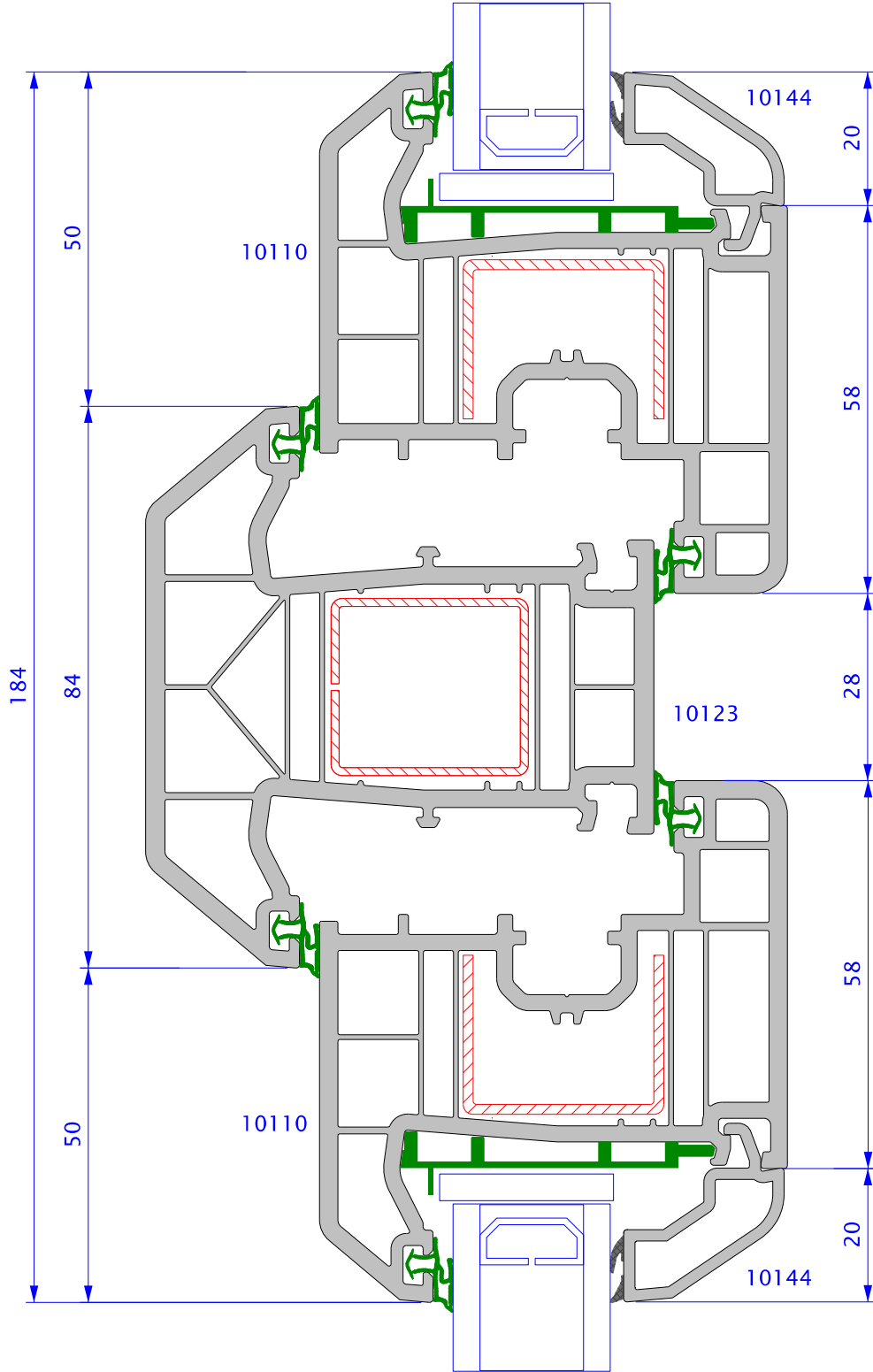
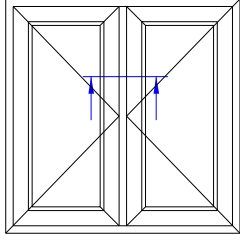

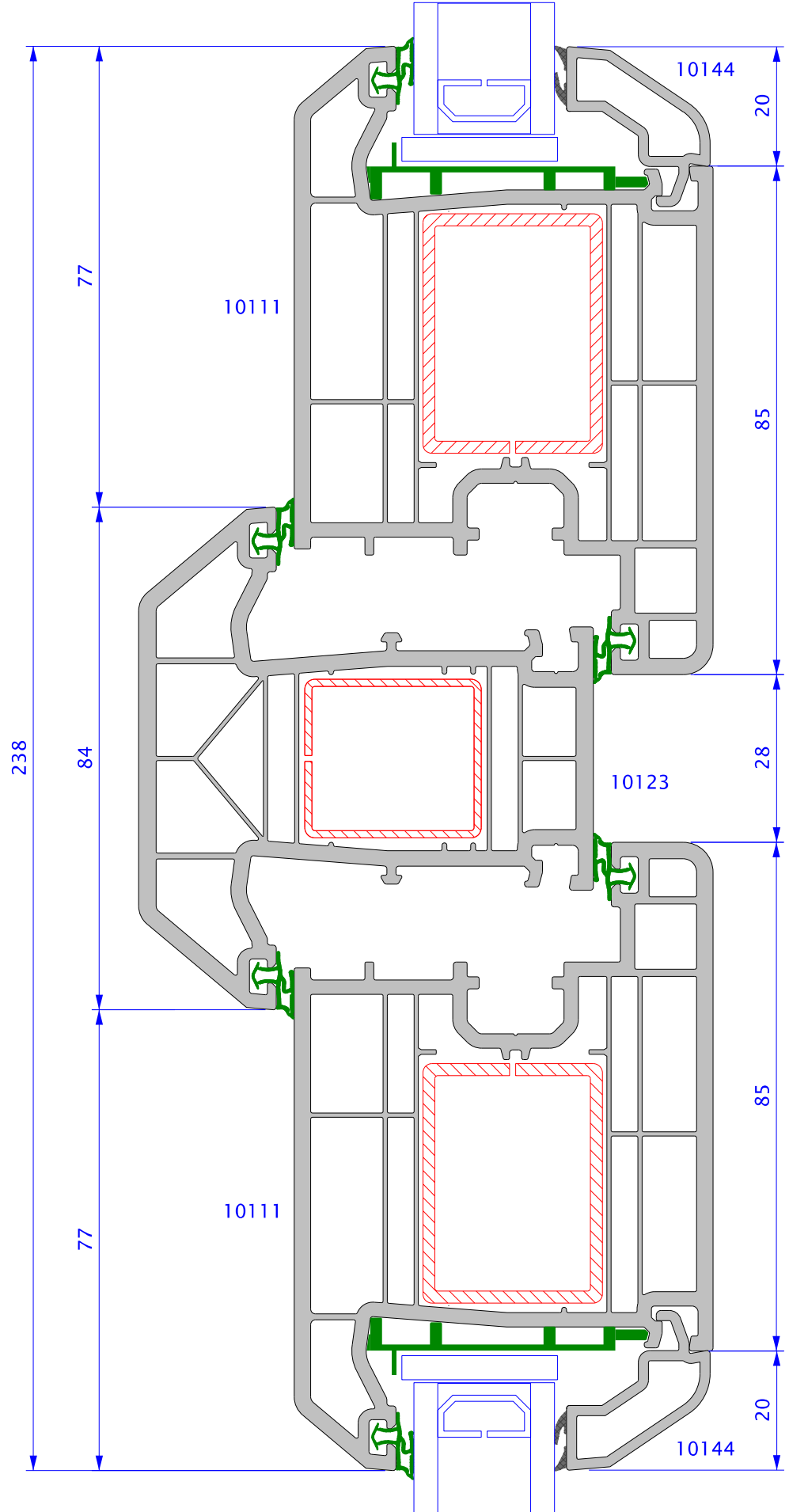
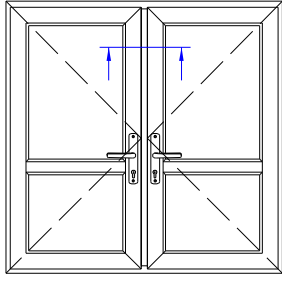

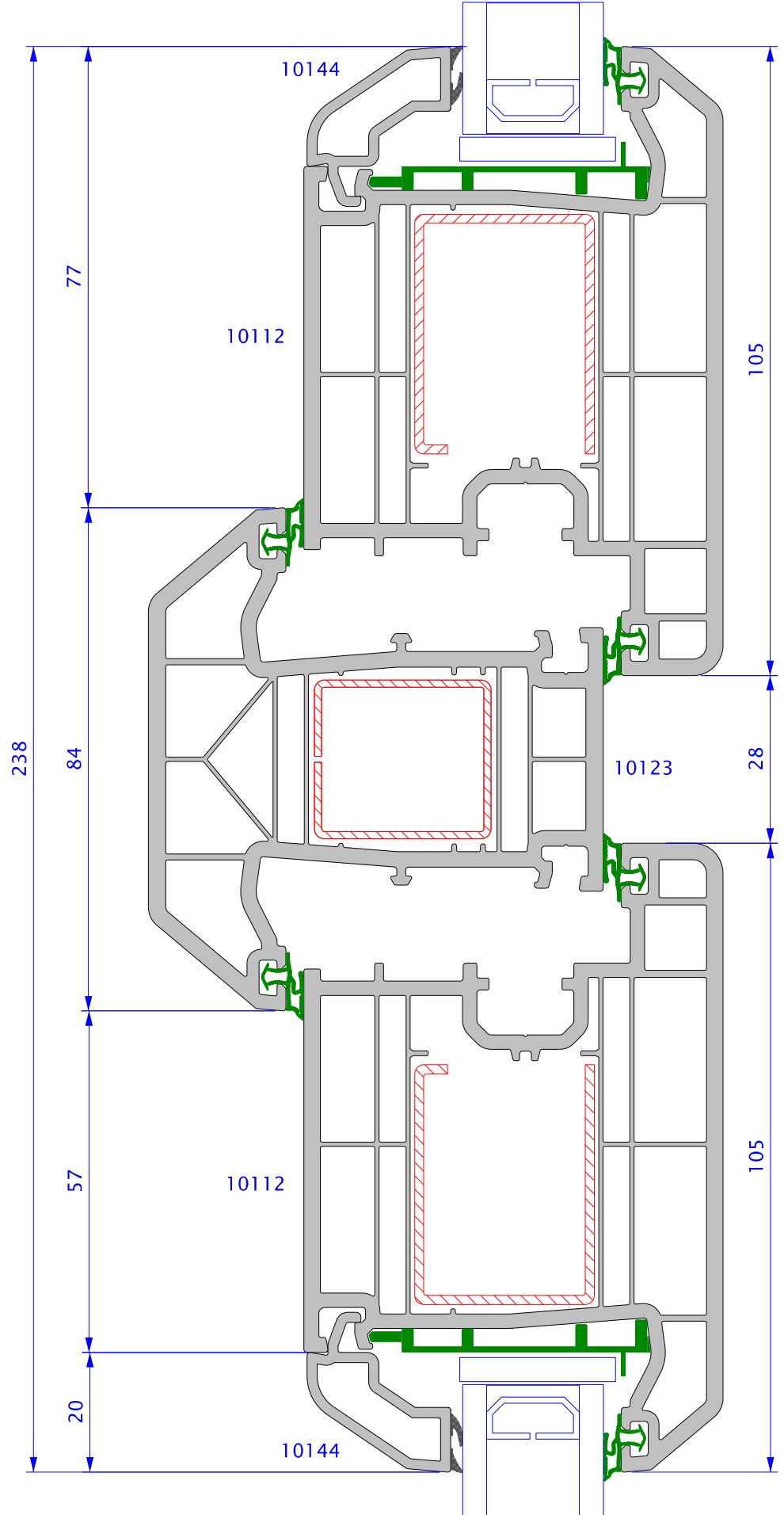
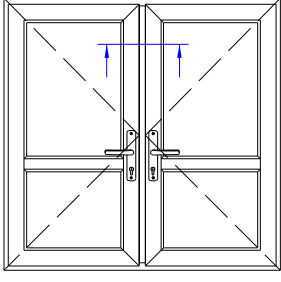

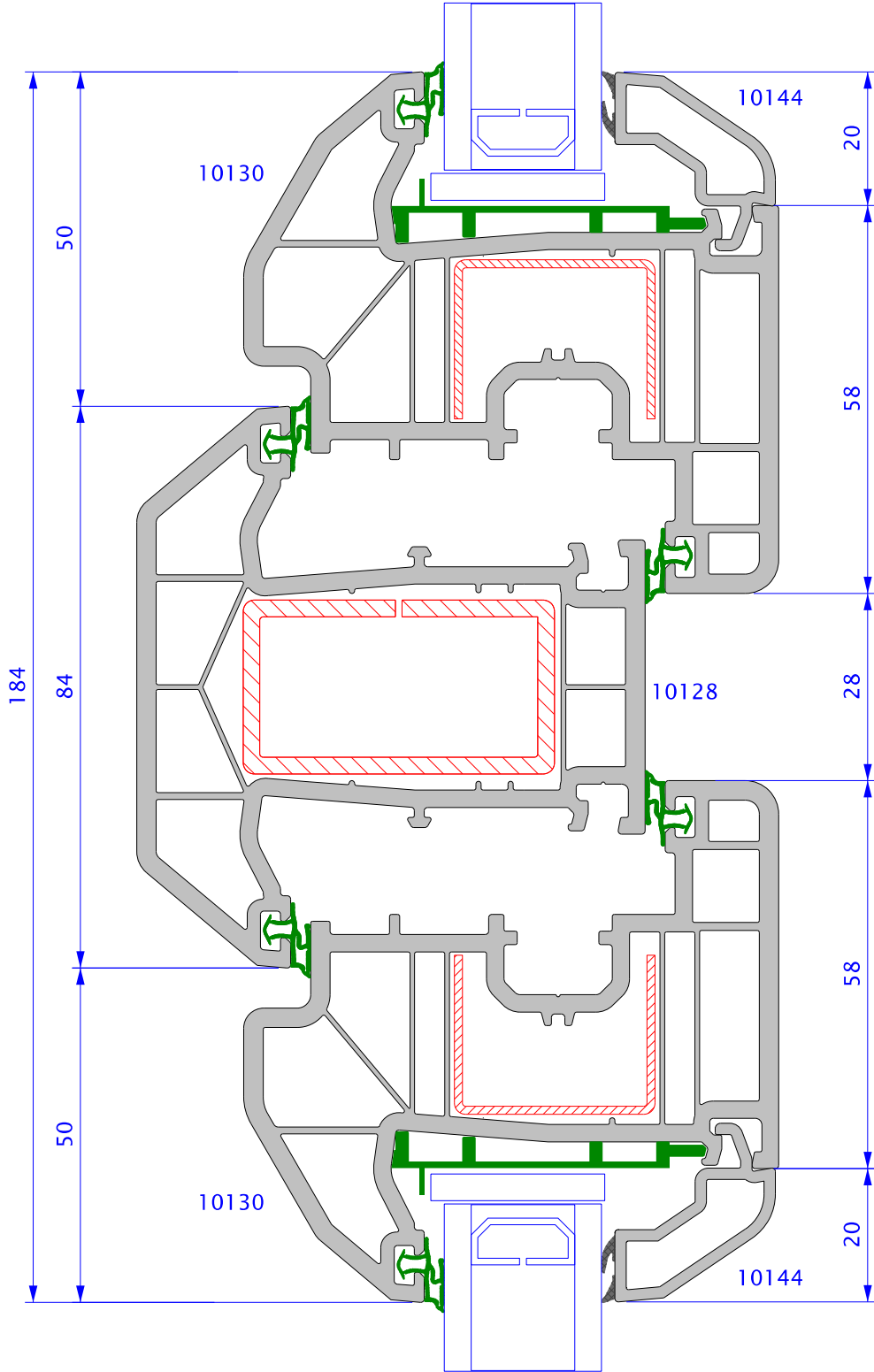
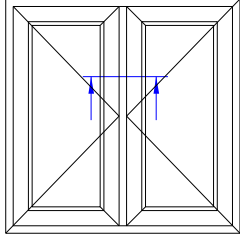

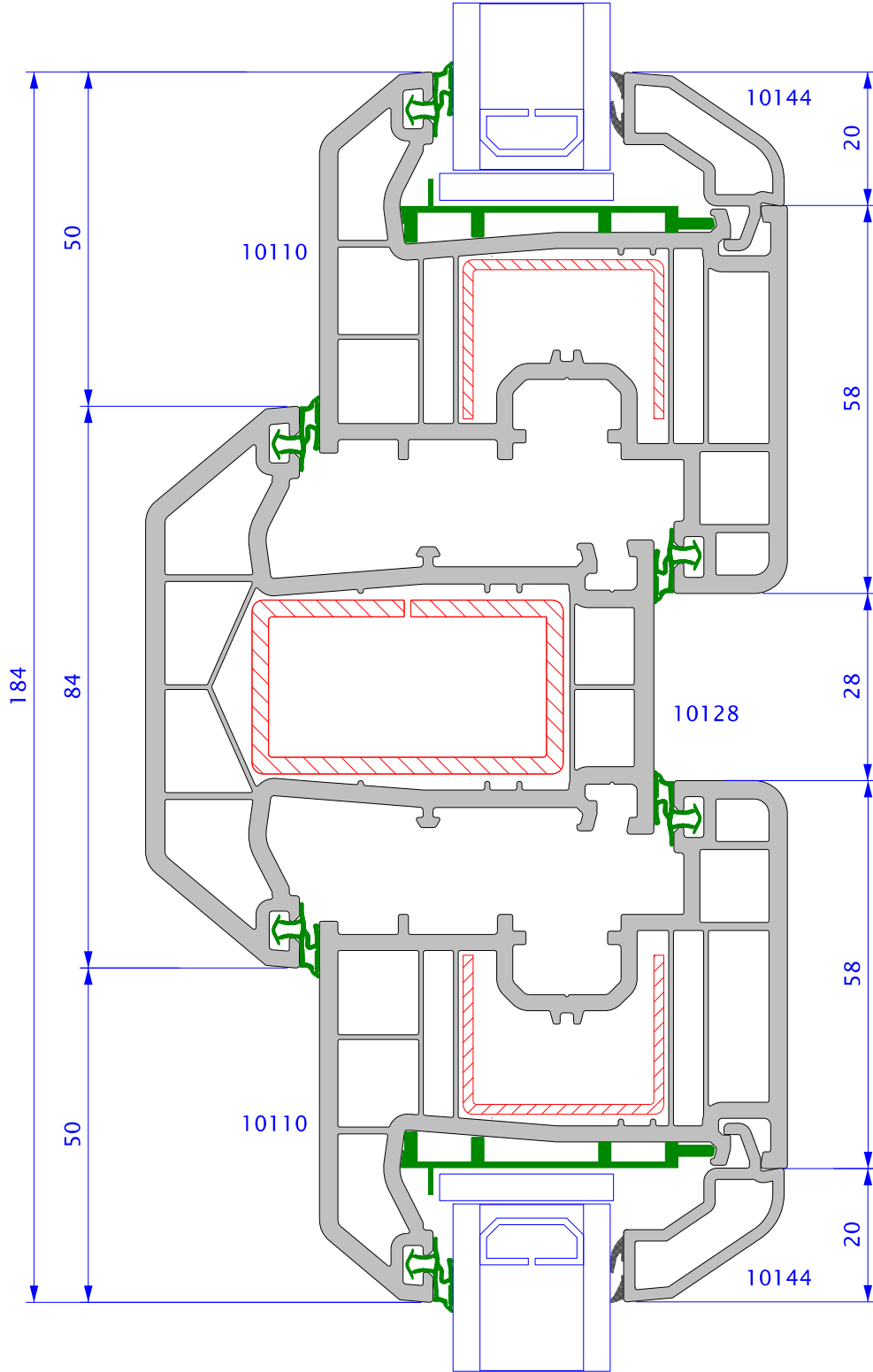
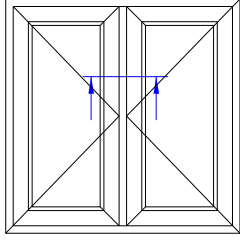

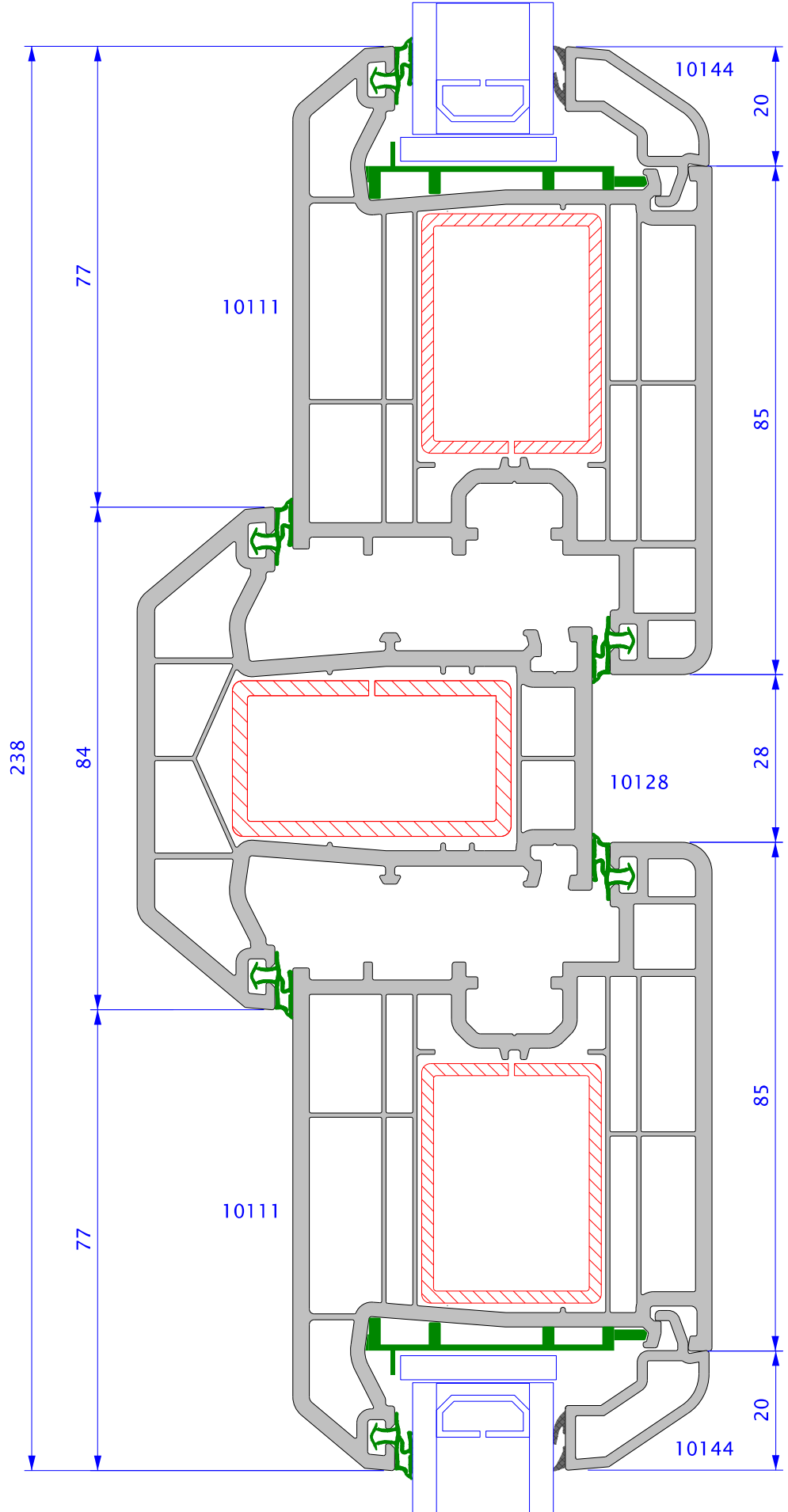
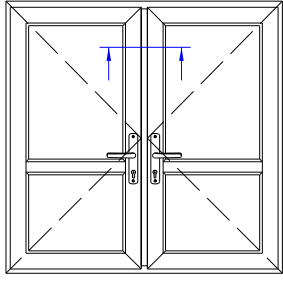

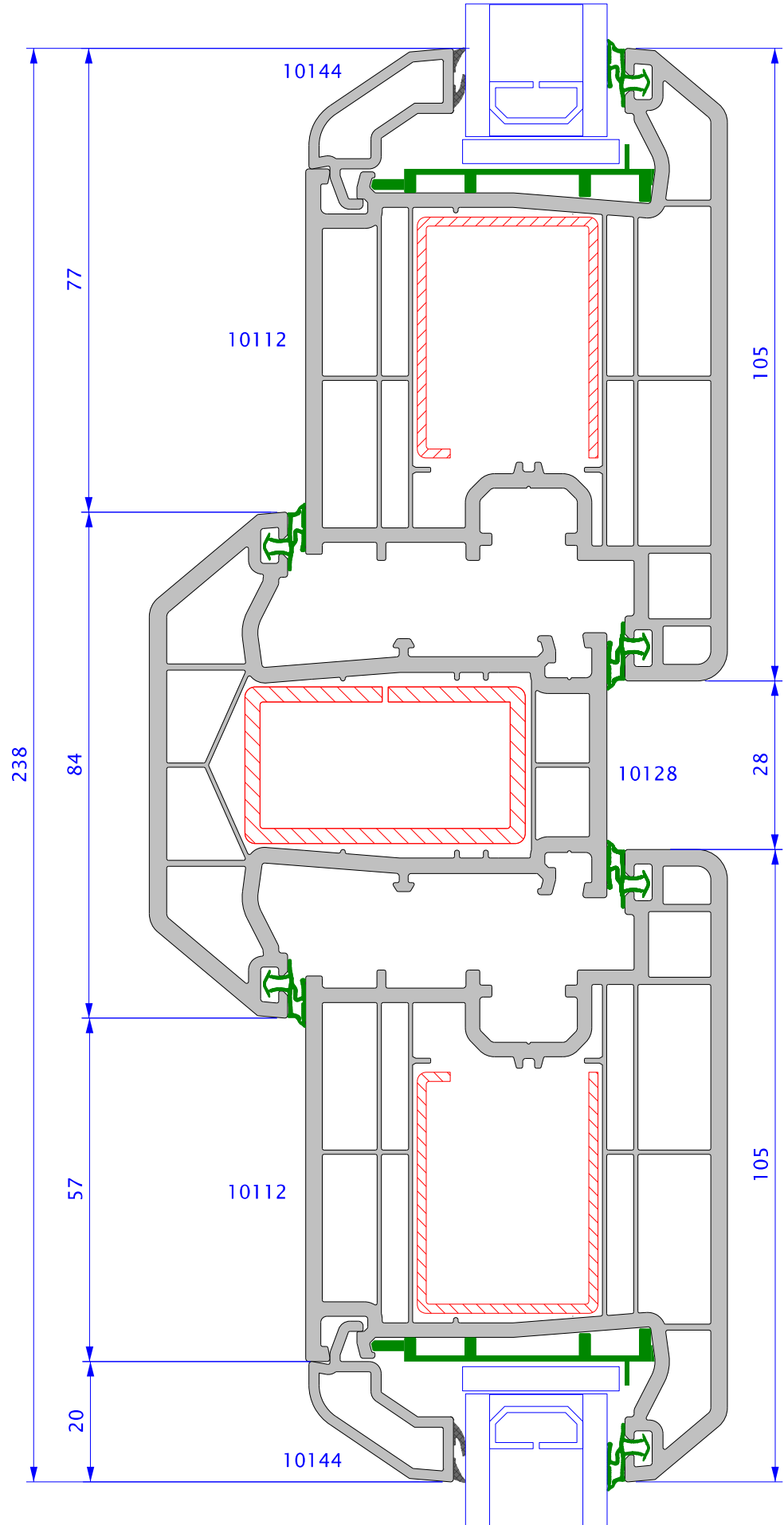
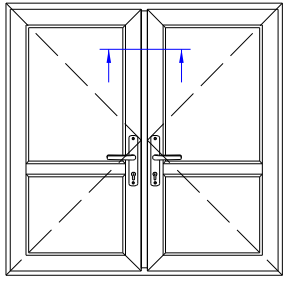



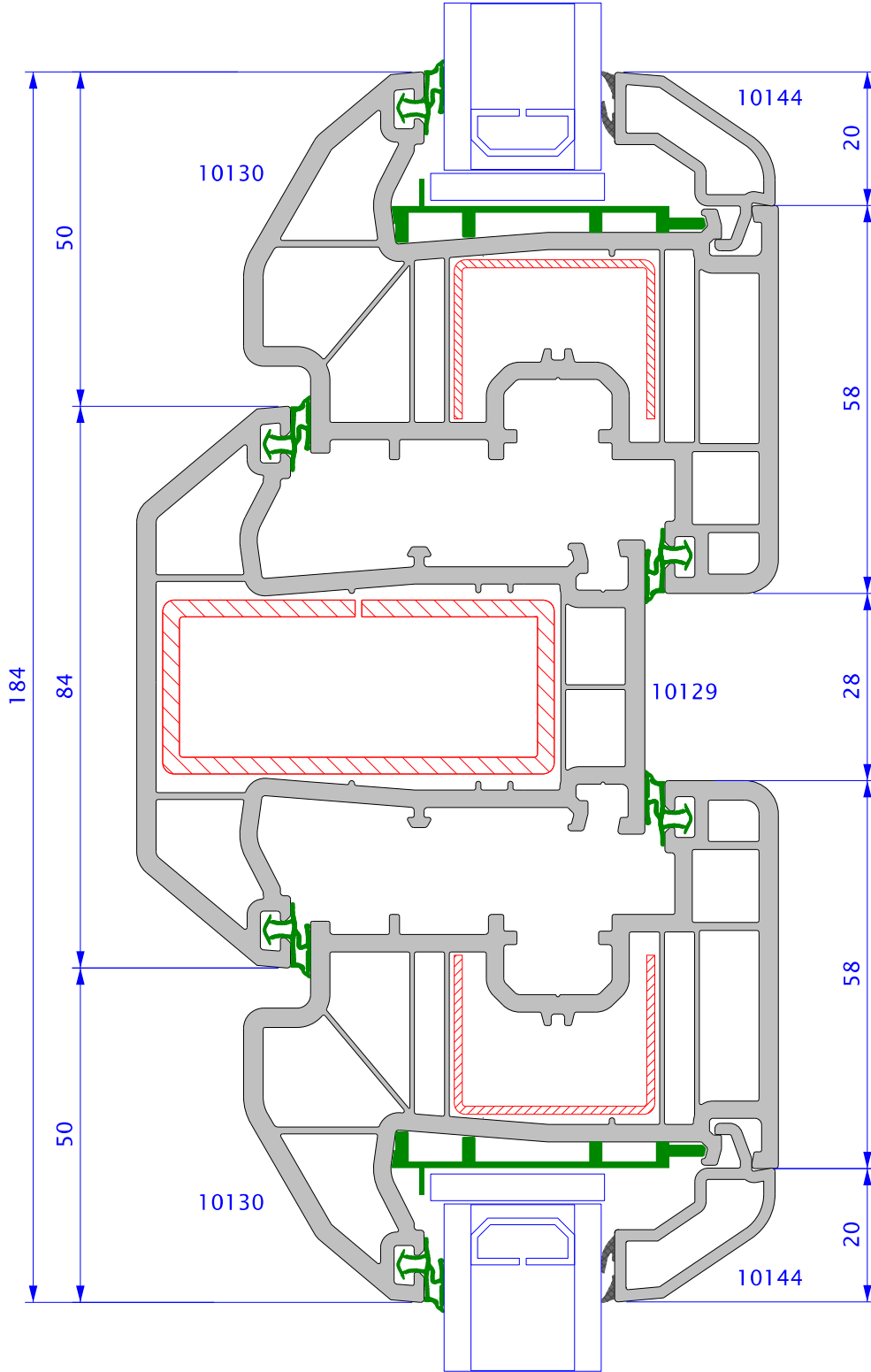
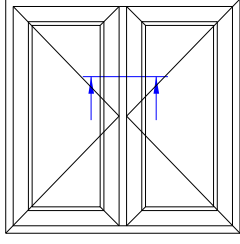

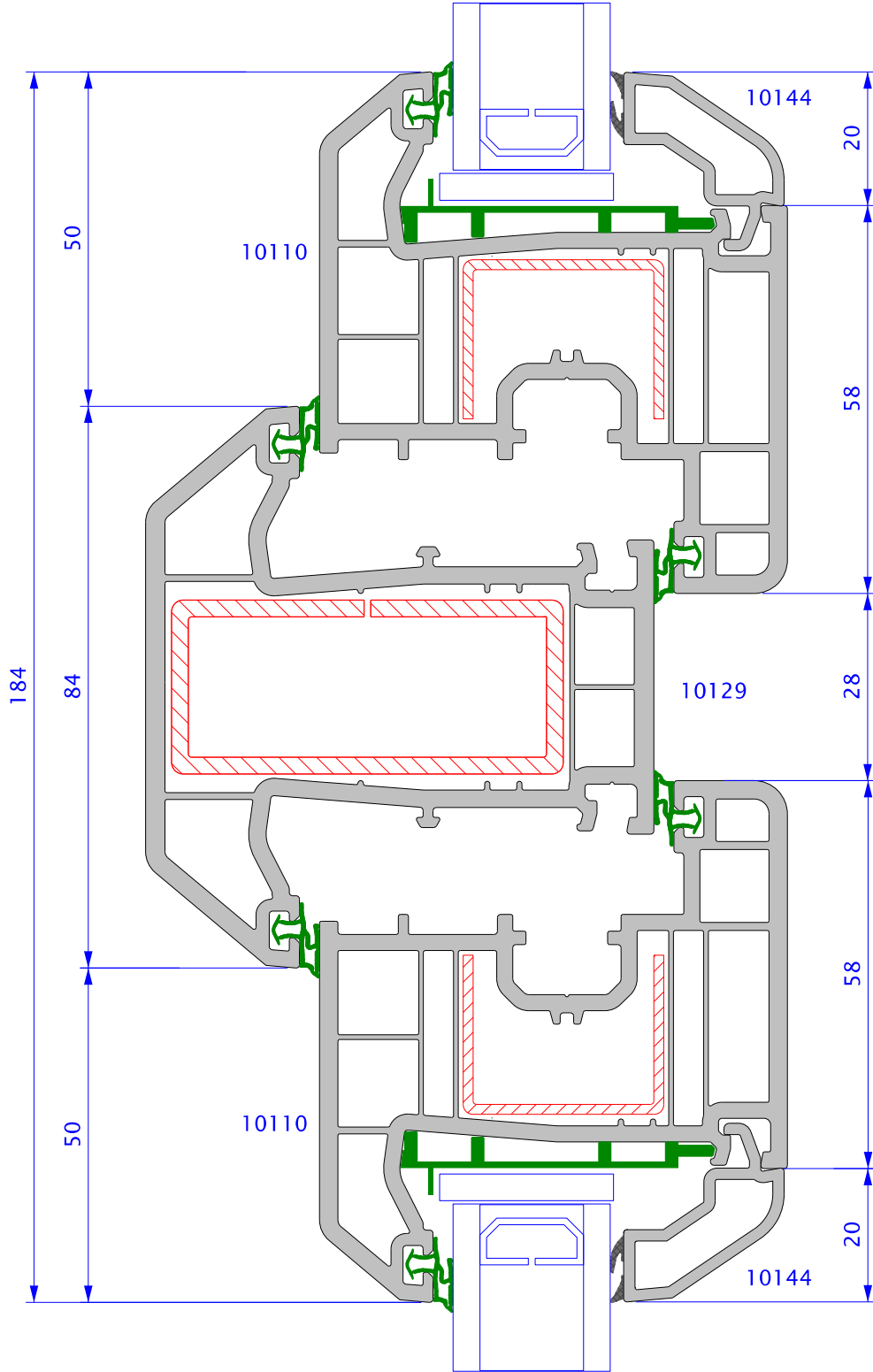
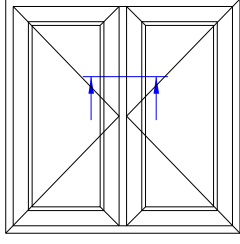

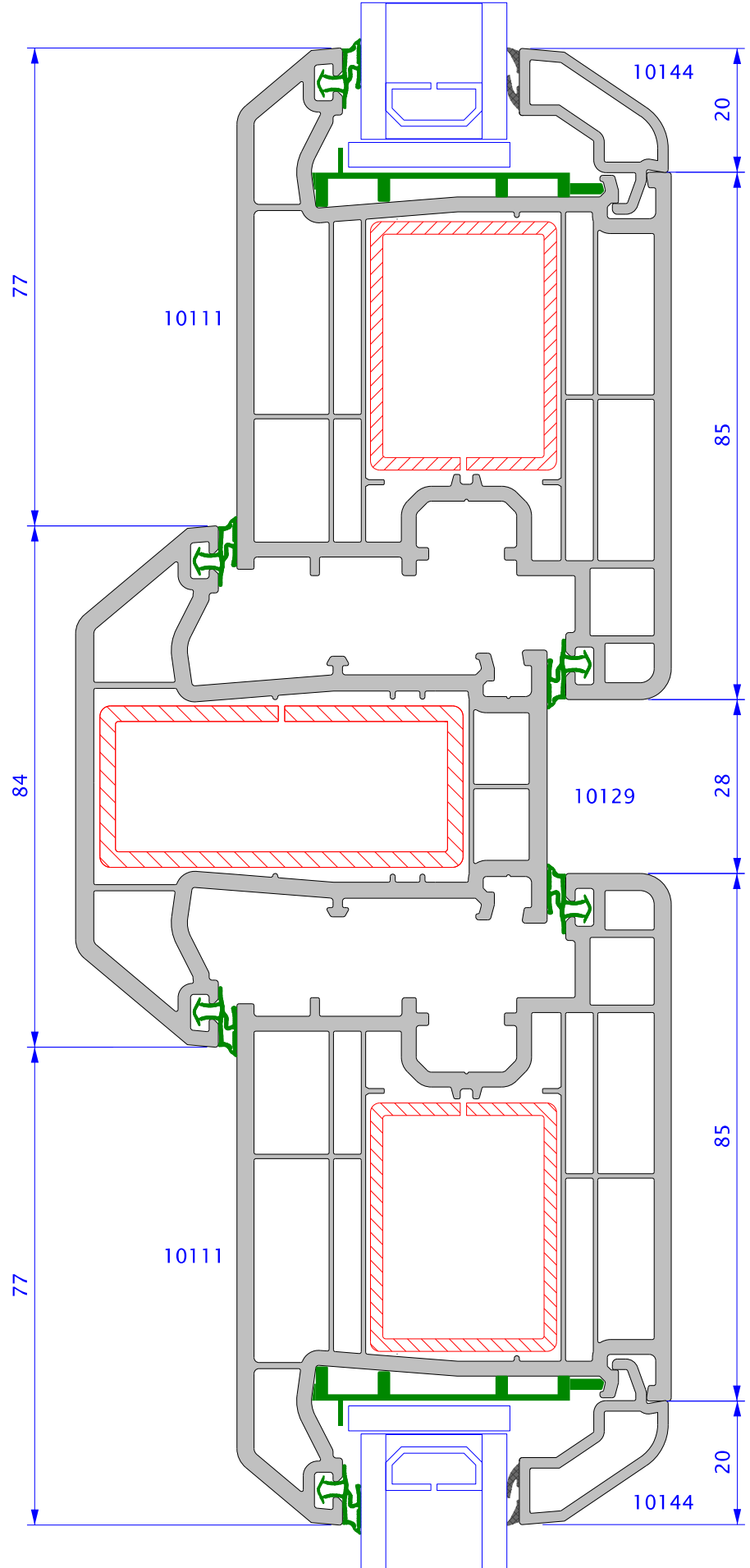
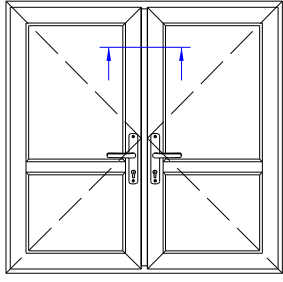

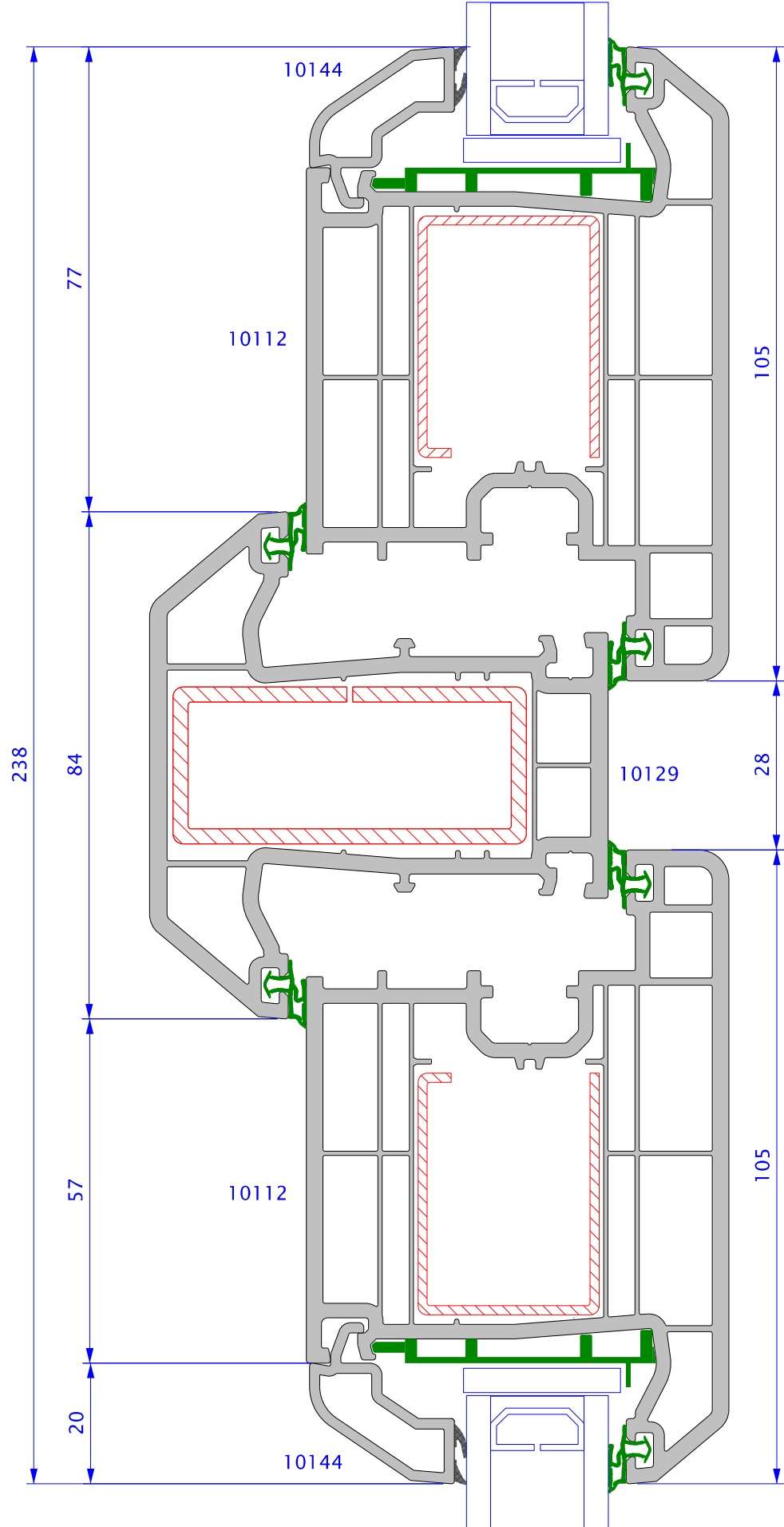
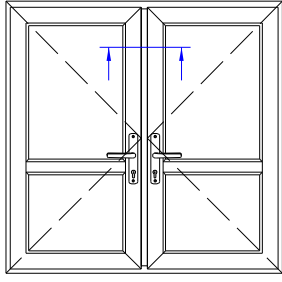

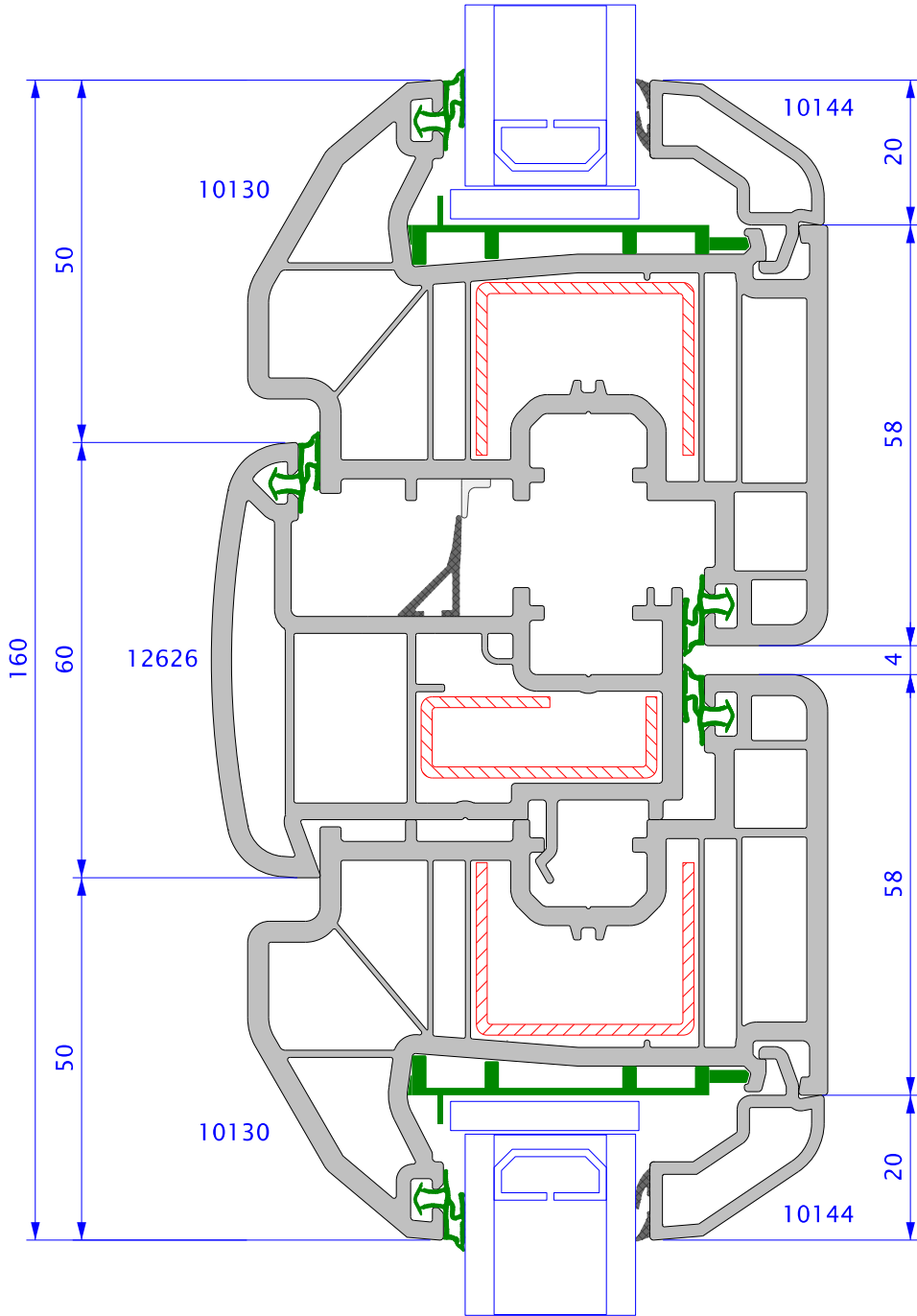
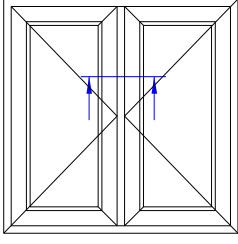

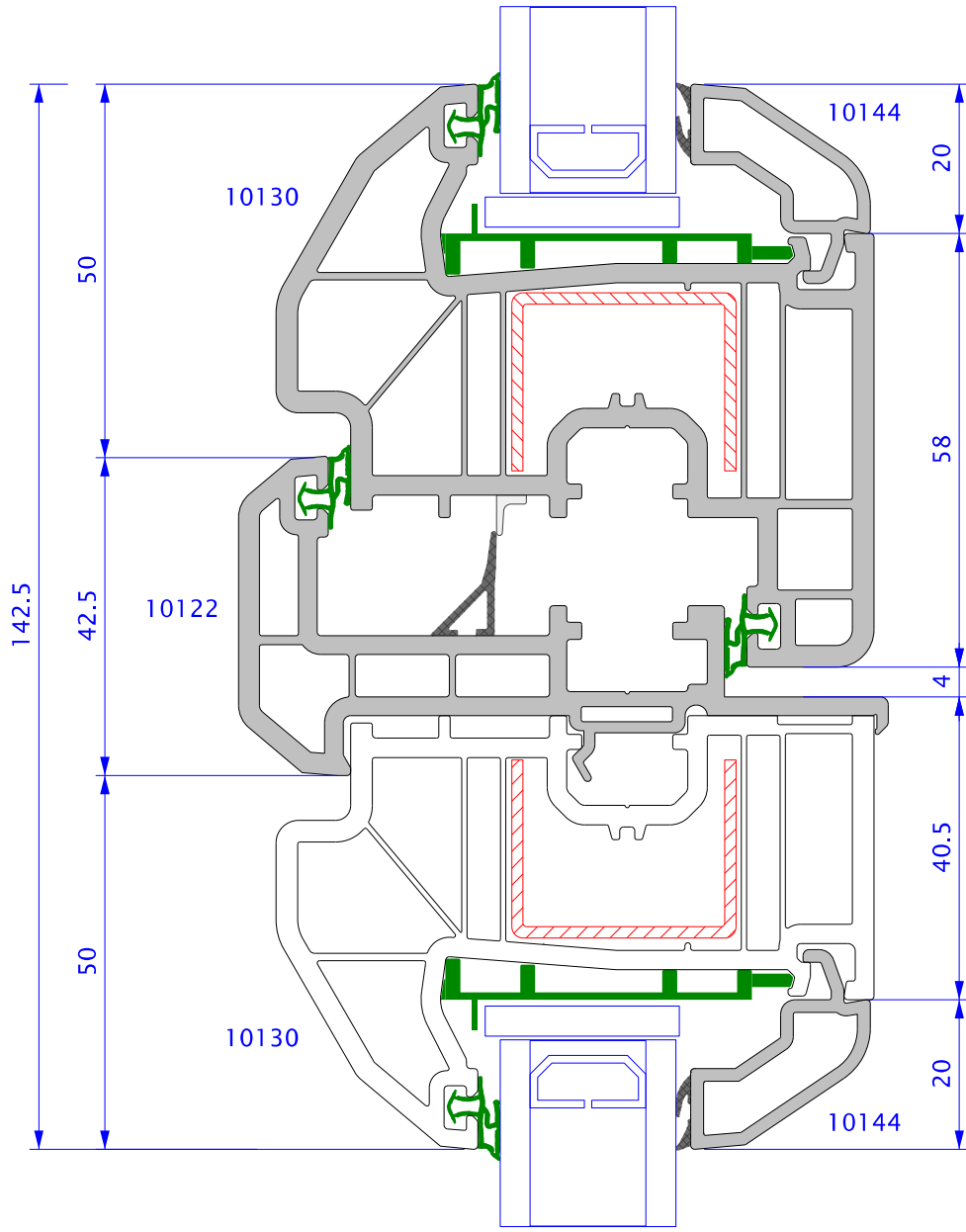
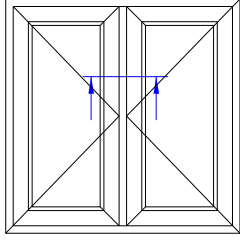

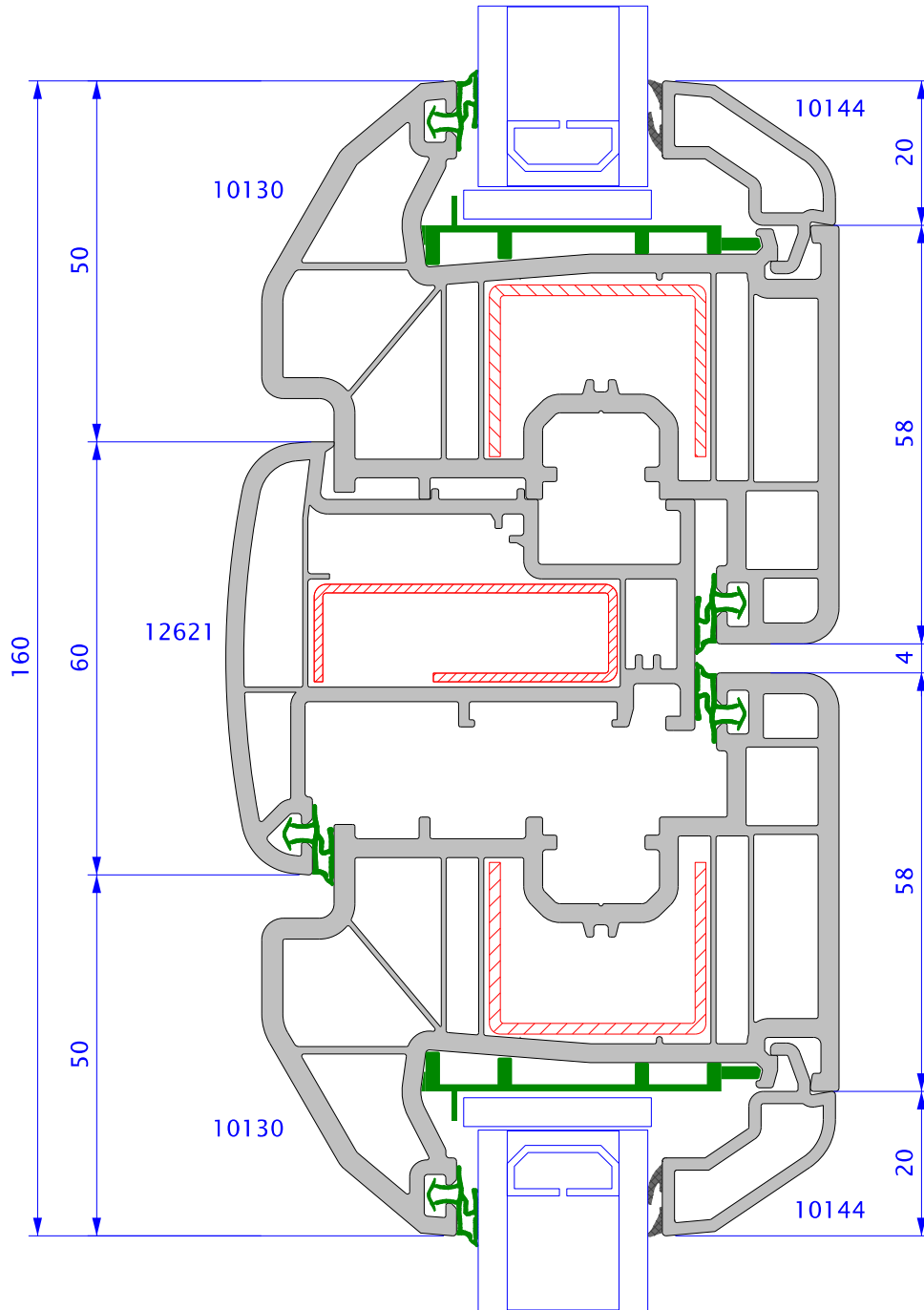
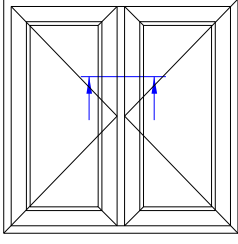

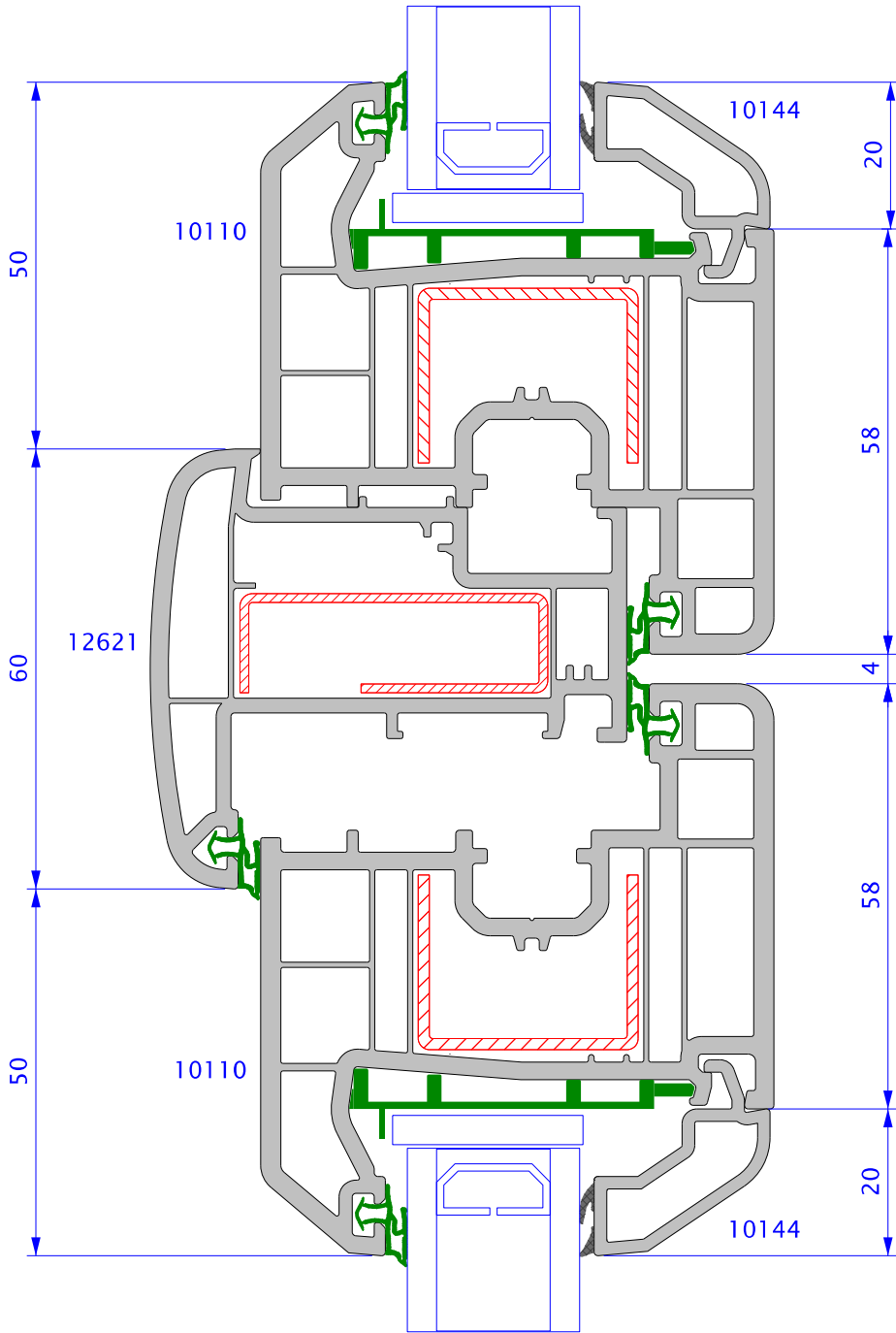
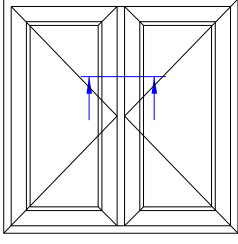



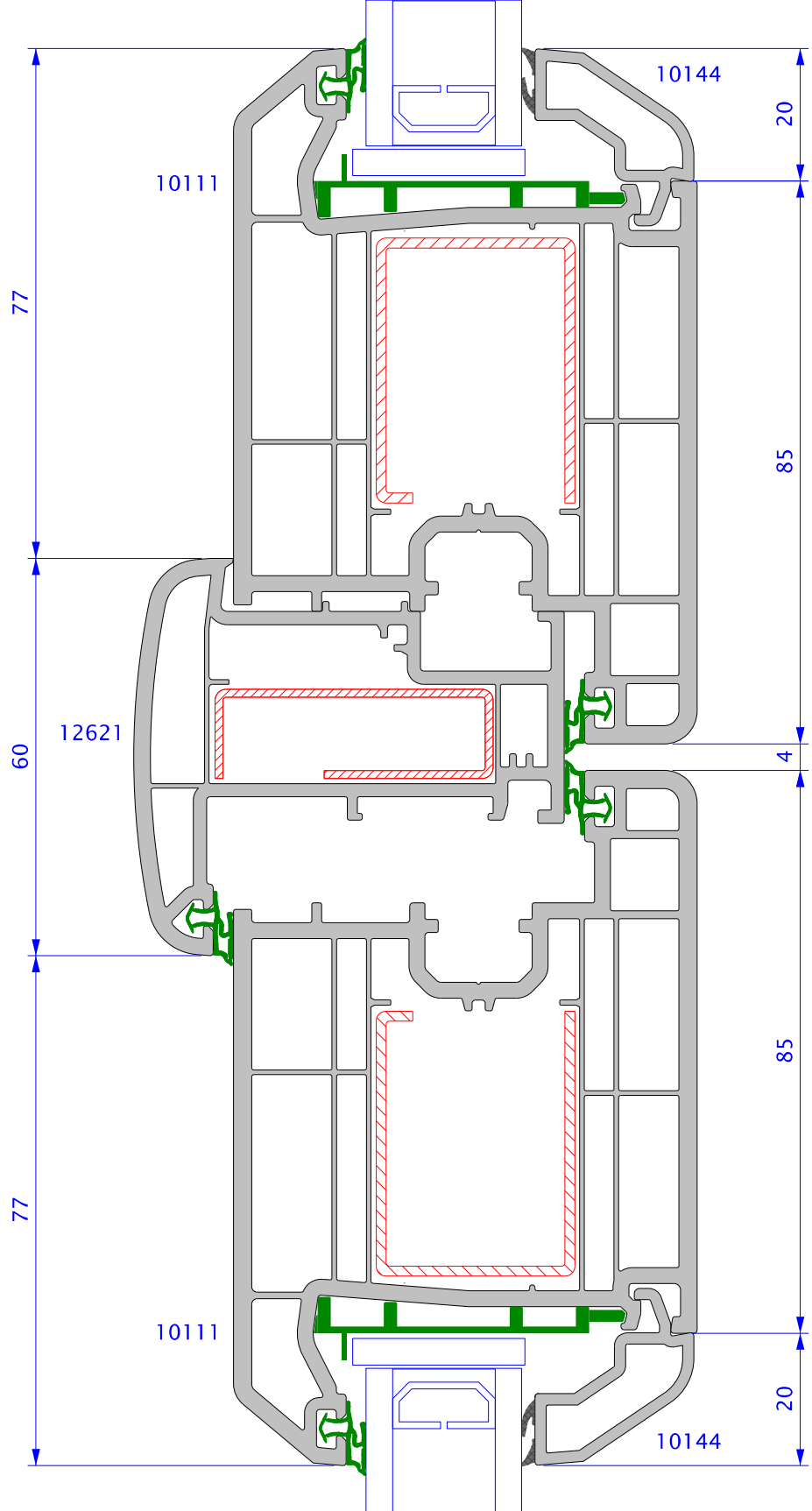
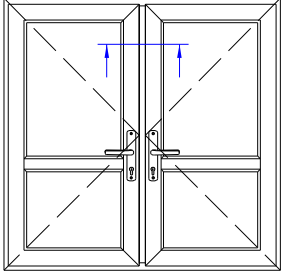

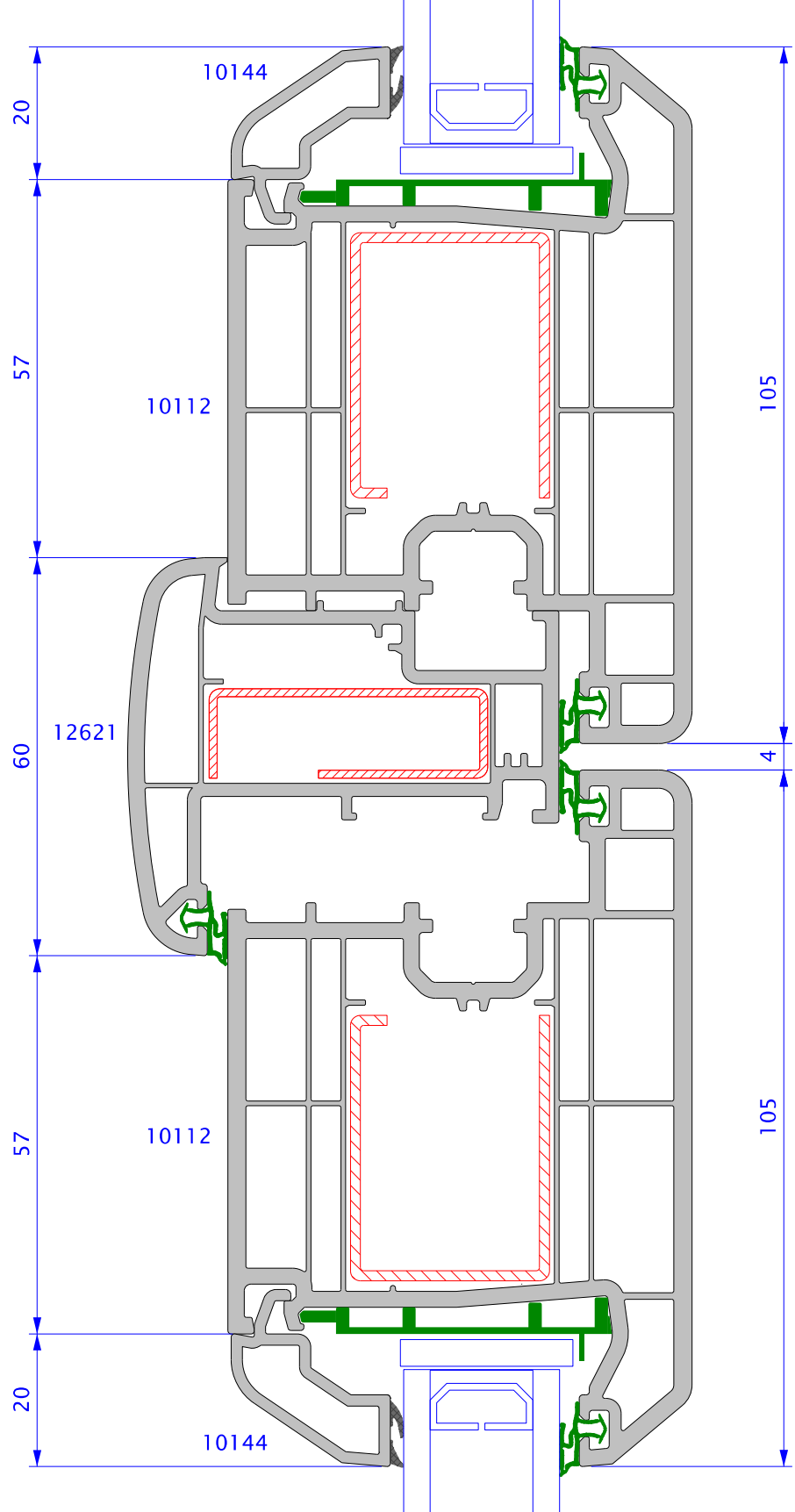
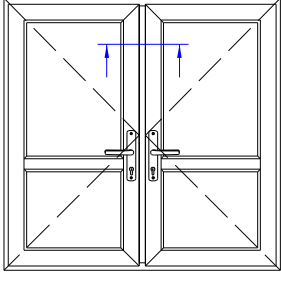

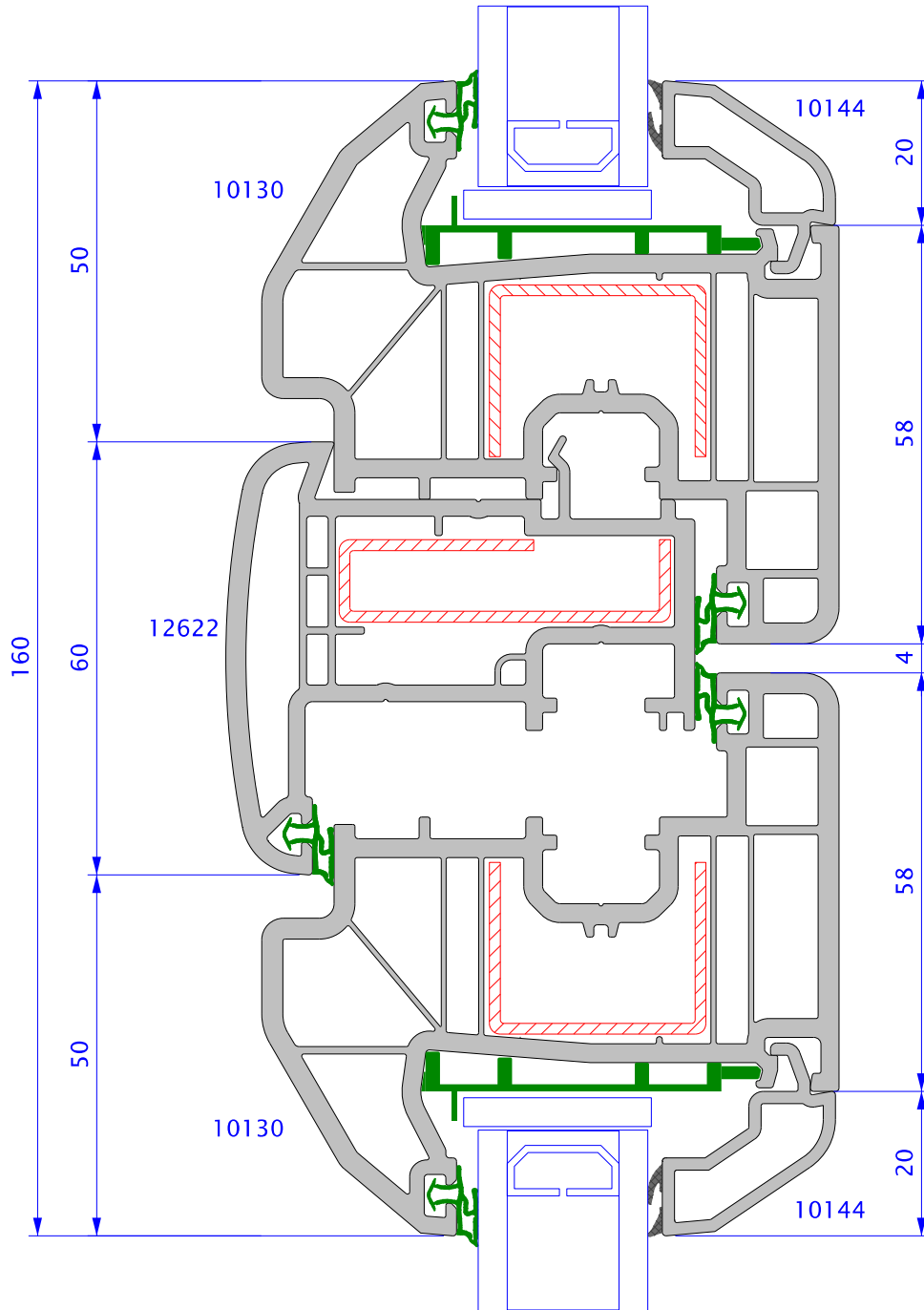
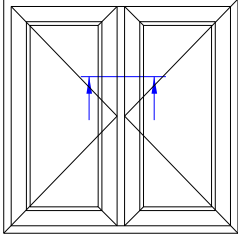

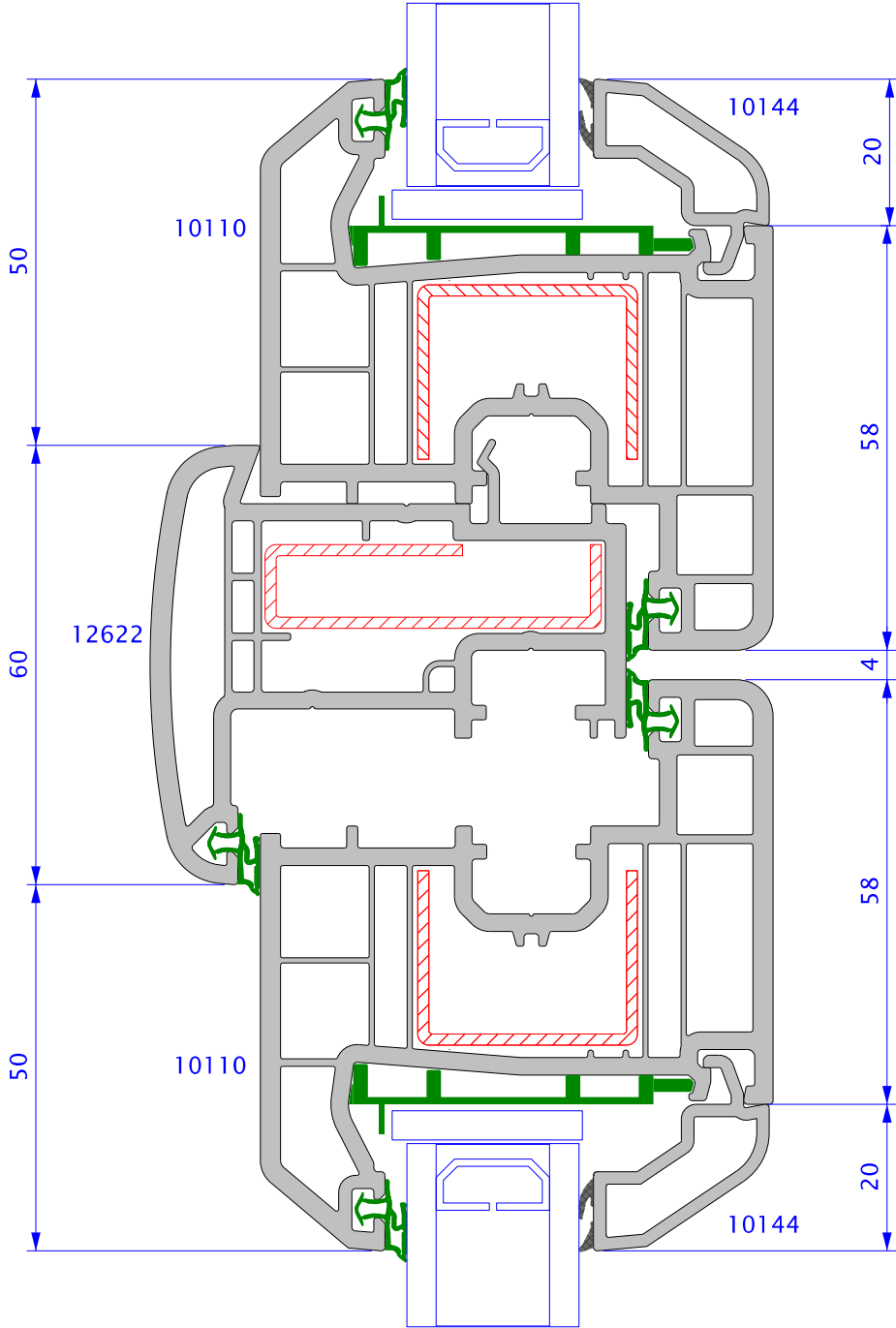
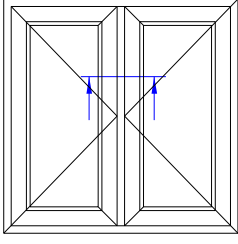

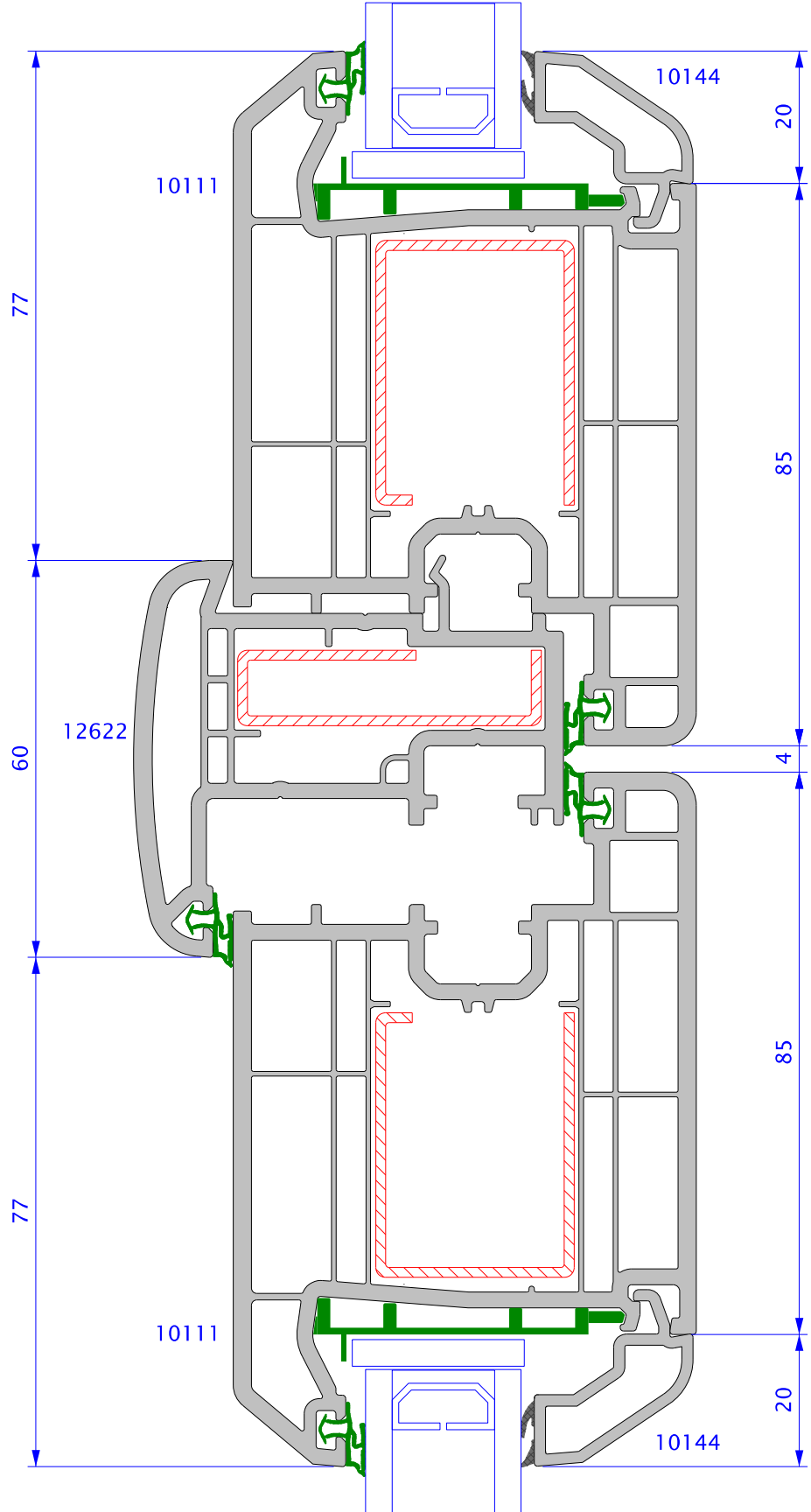
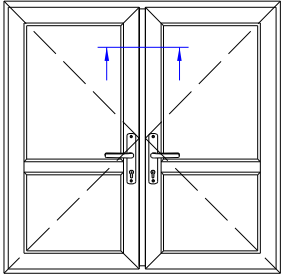

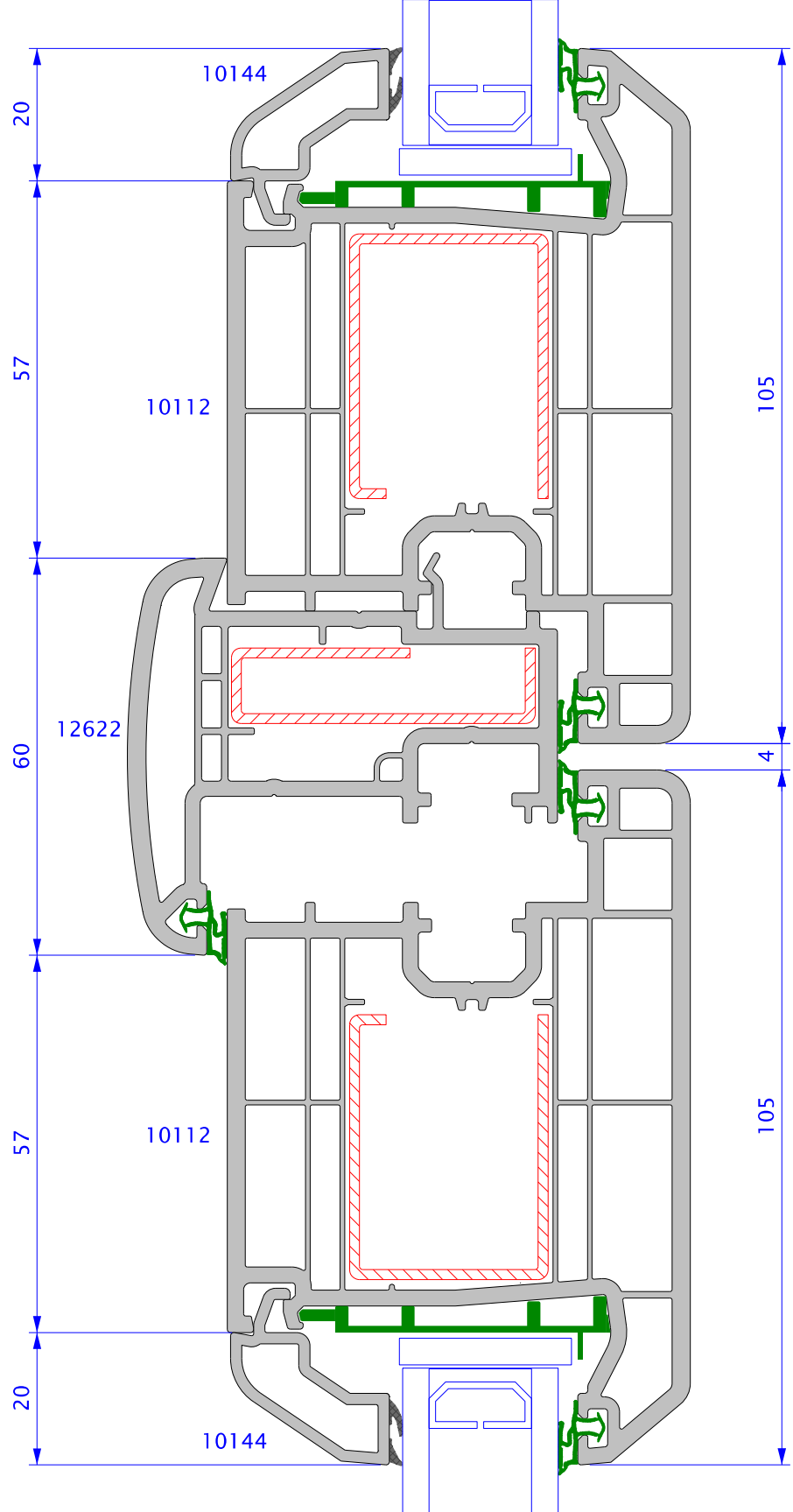
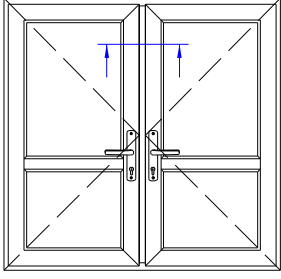

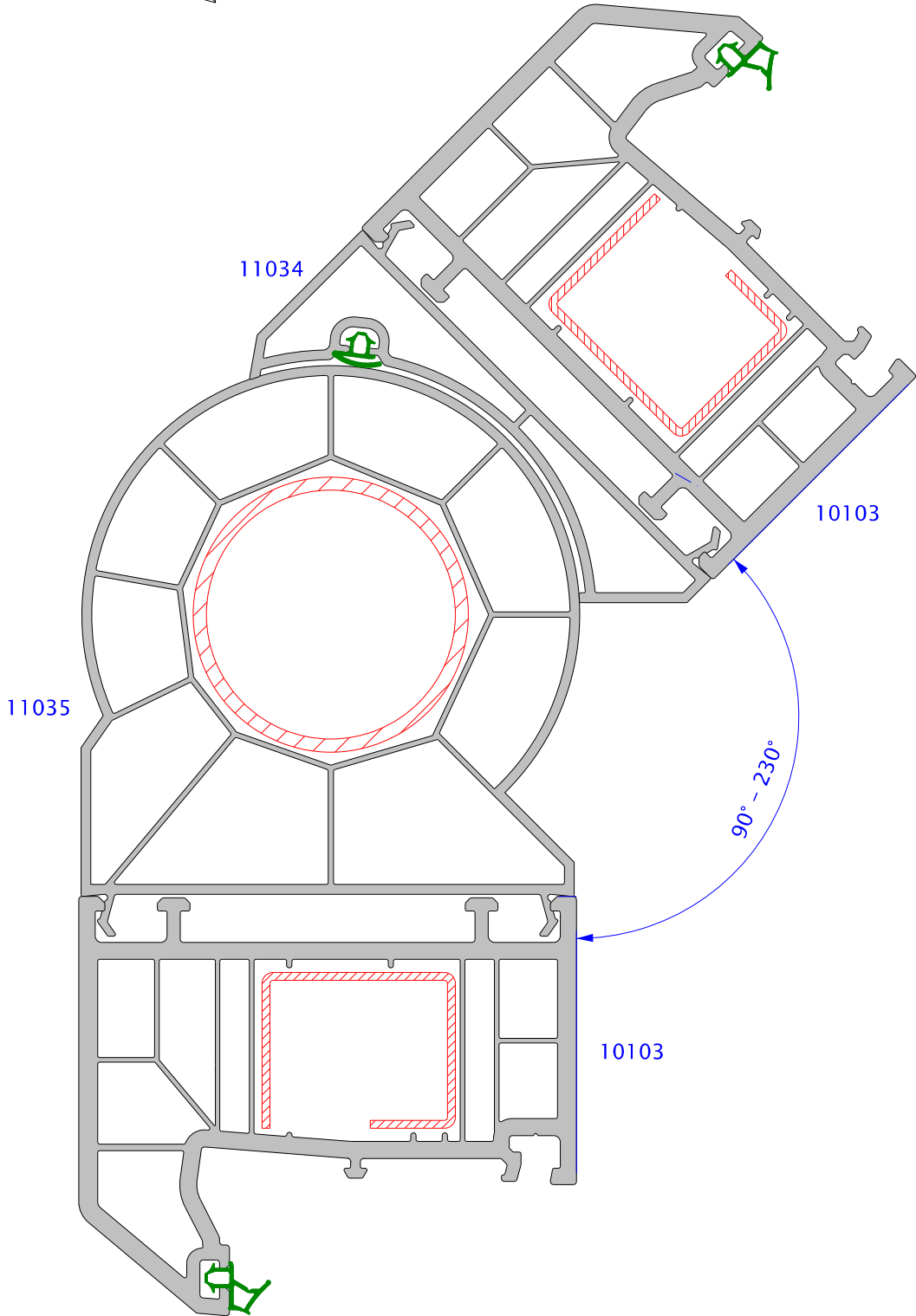
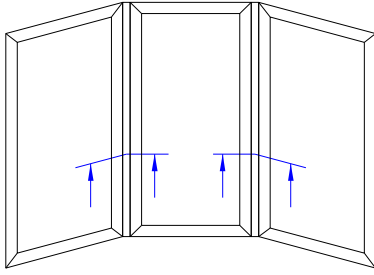

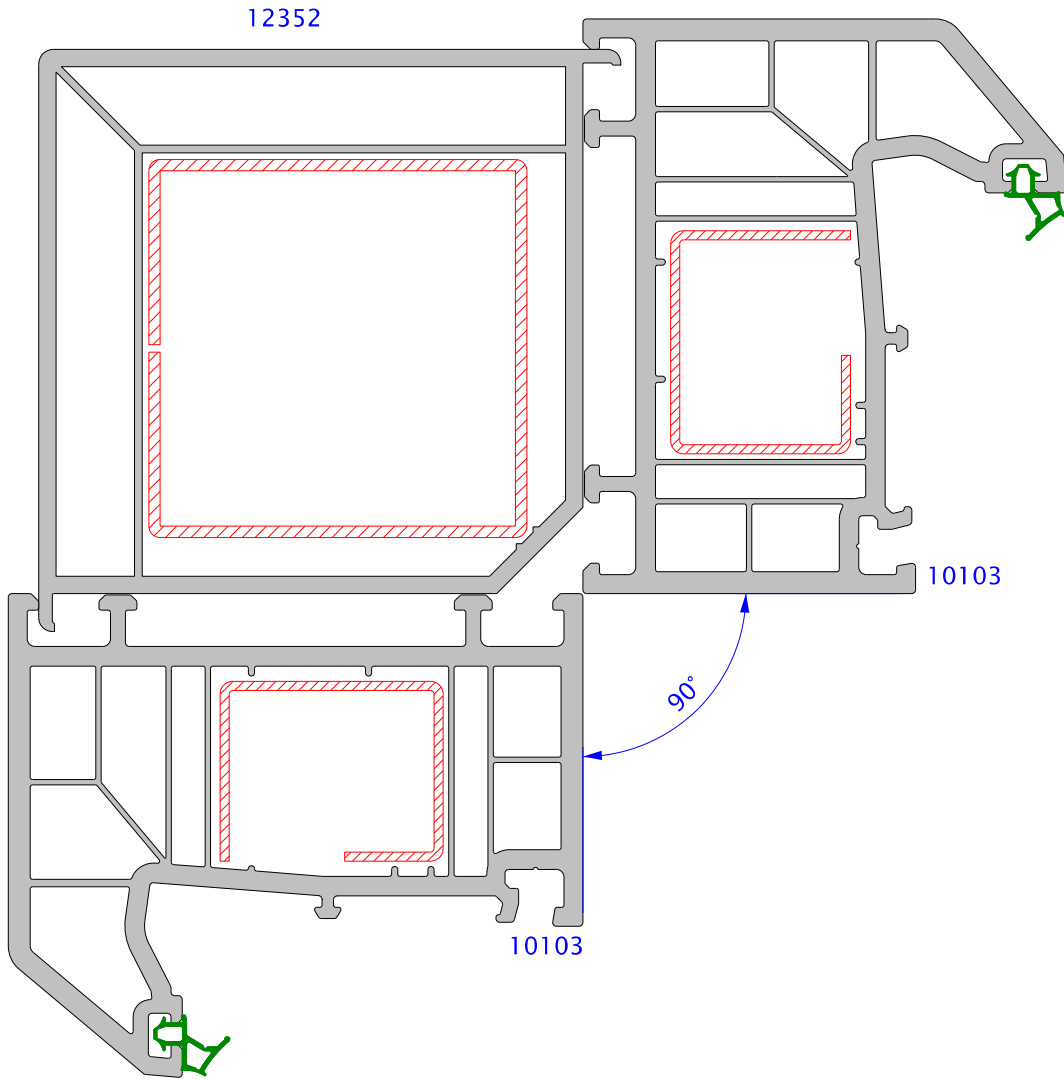
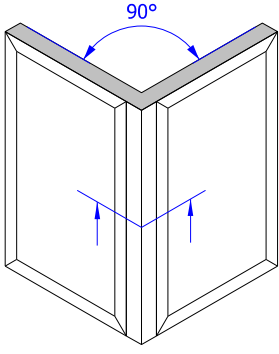



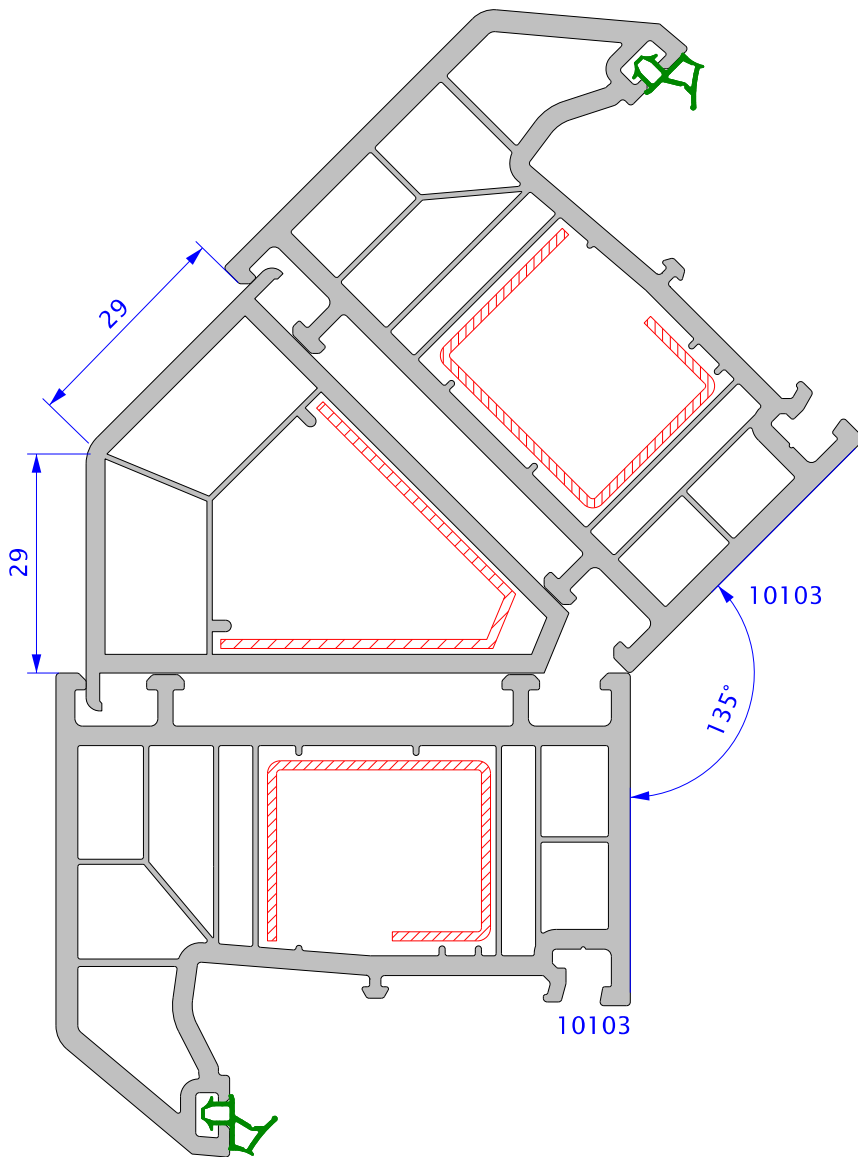
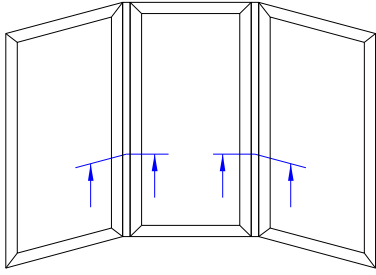

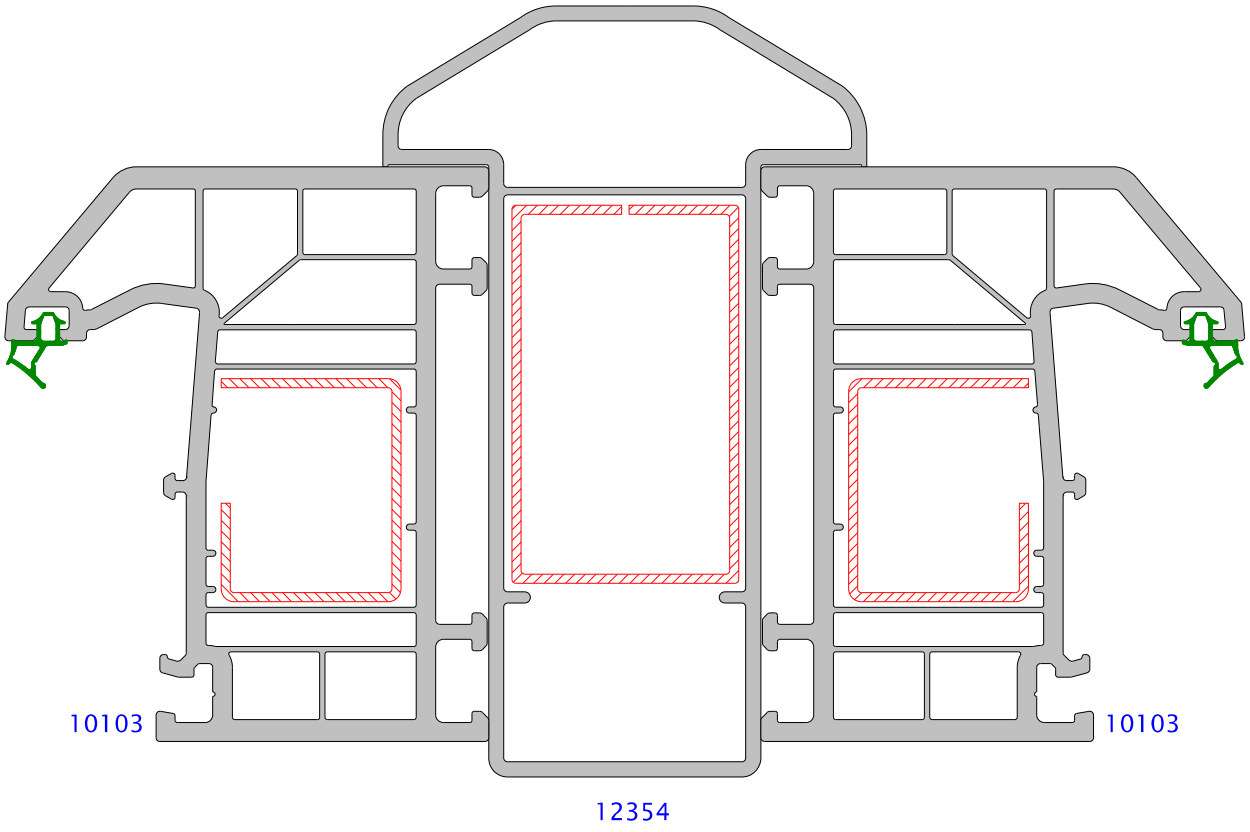

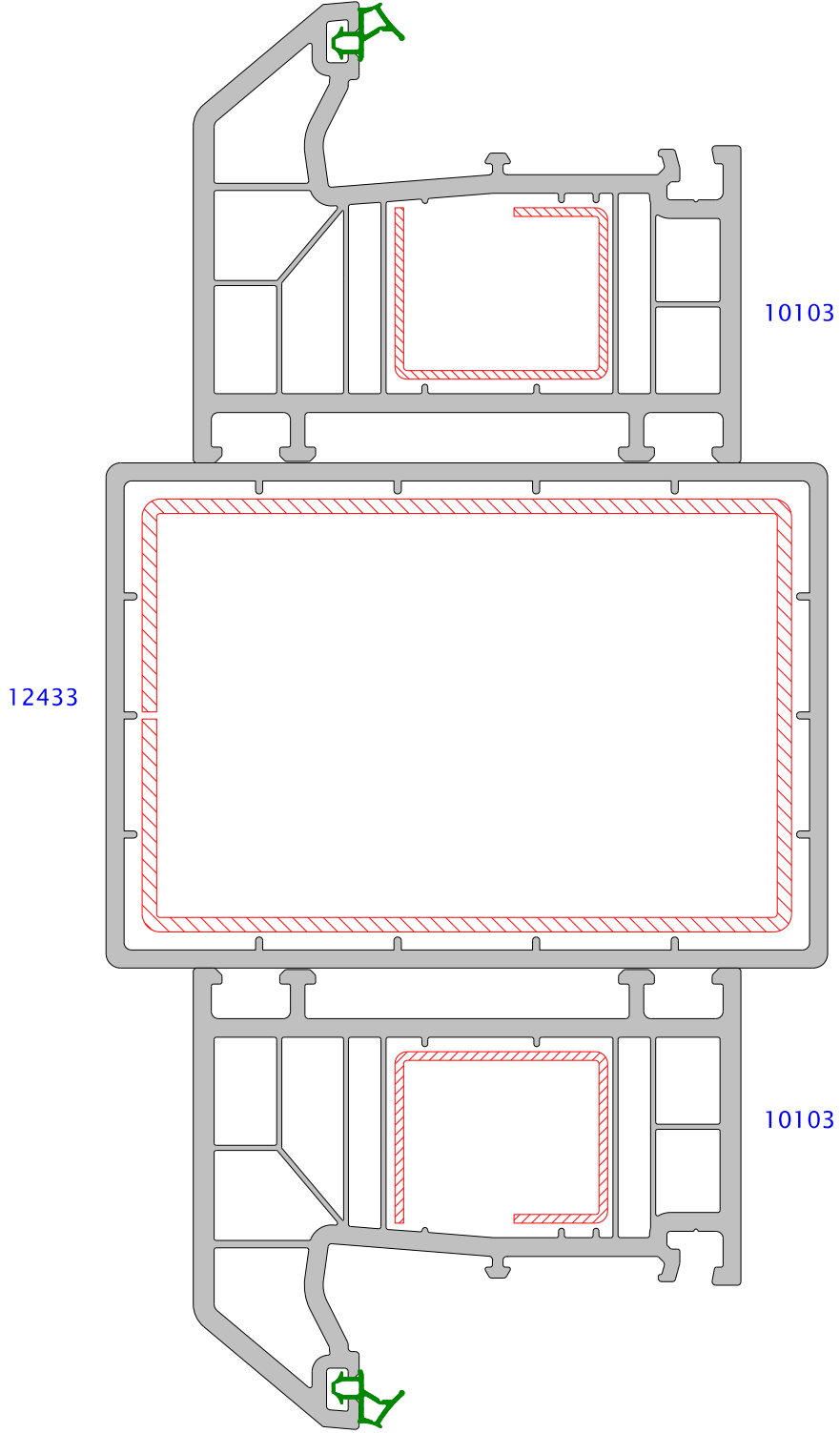

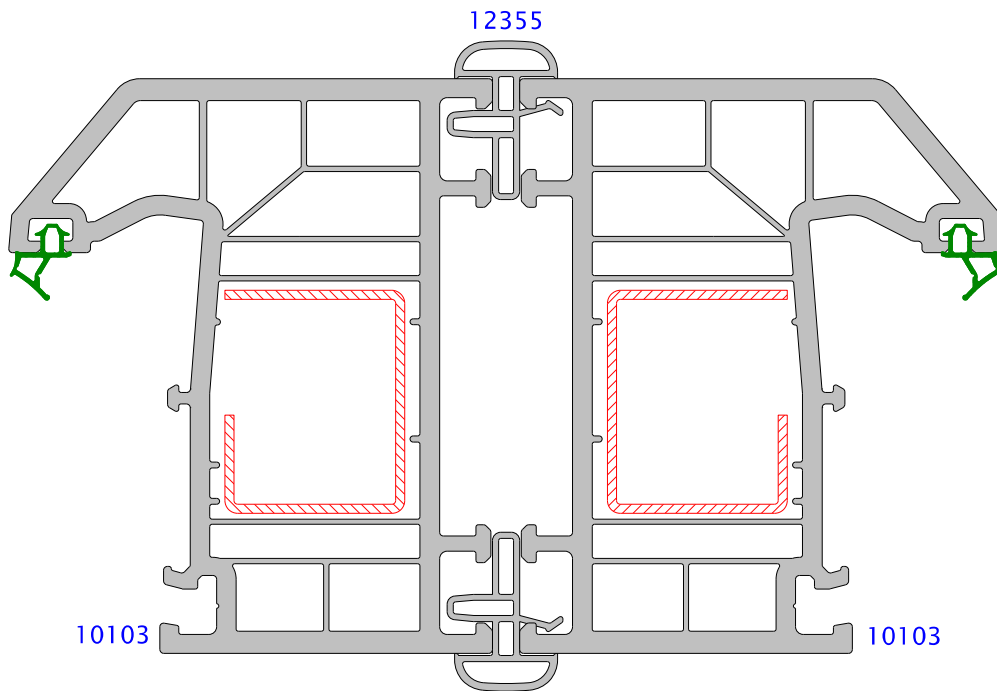
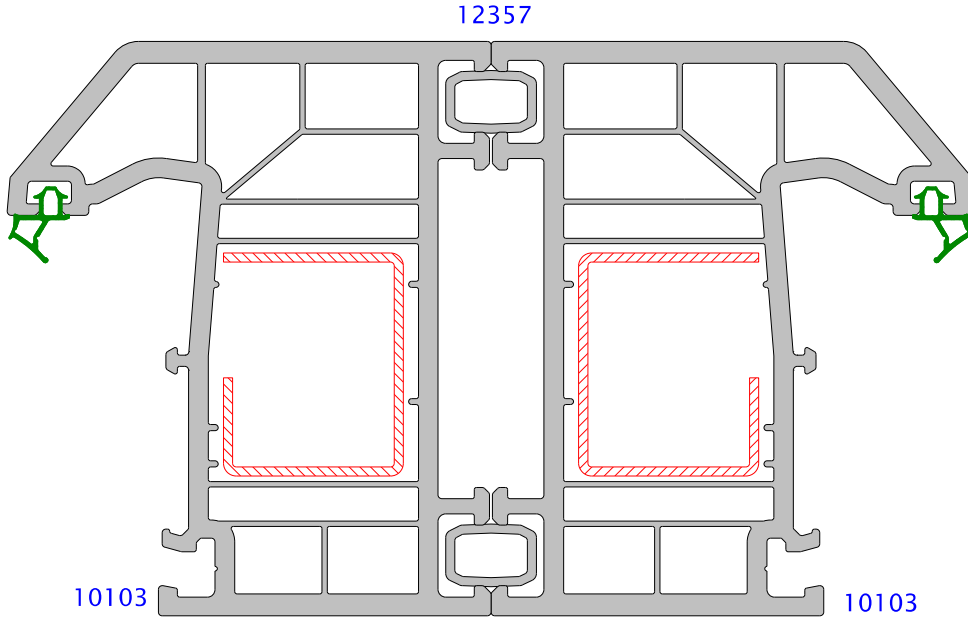
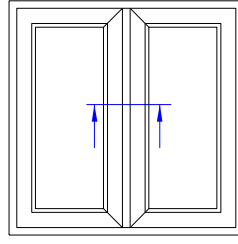

10123

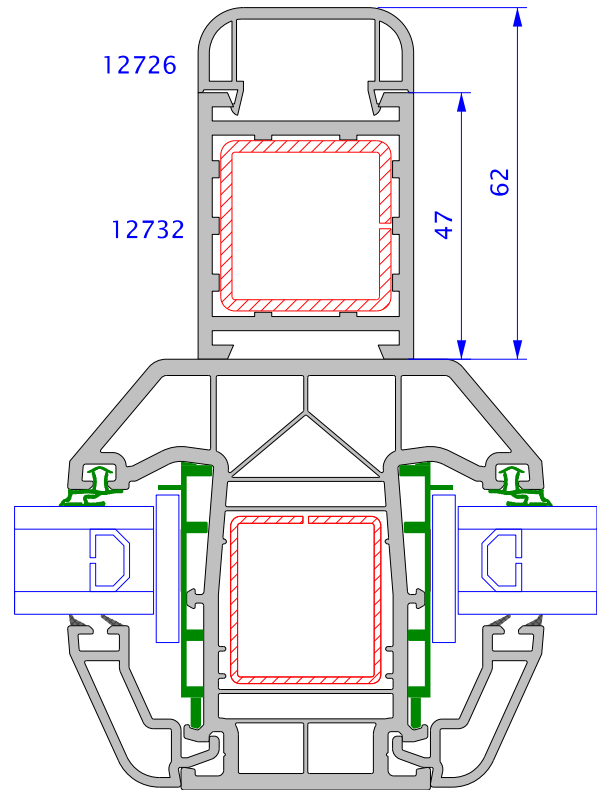
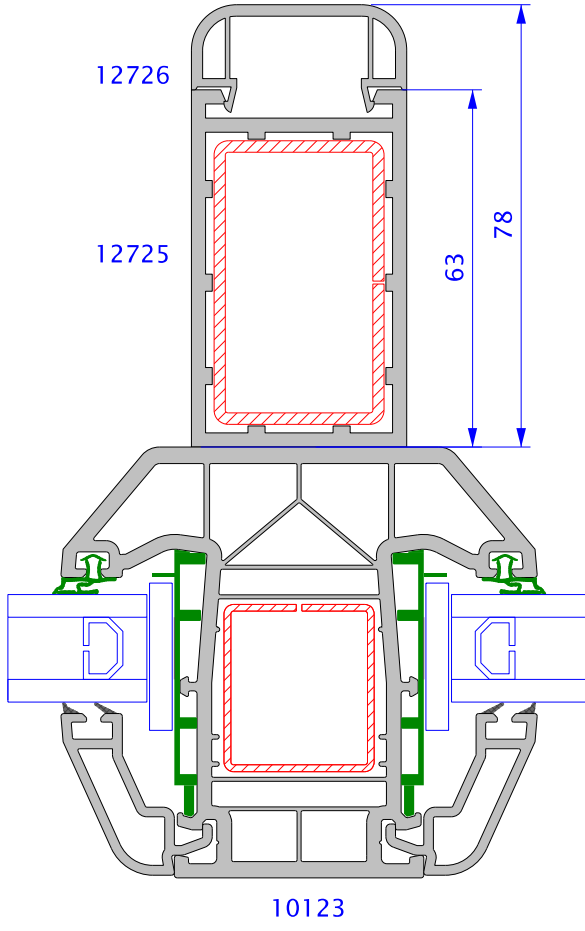

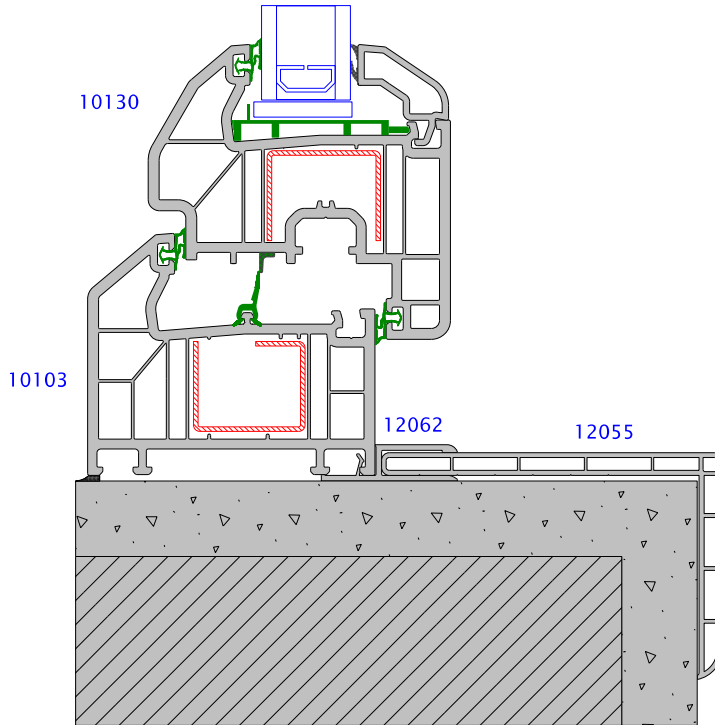
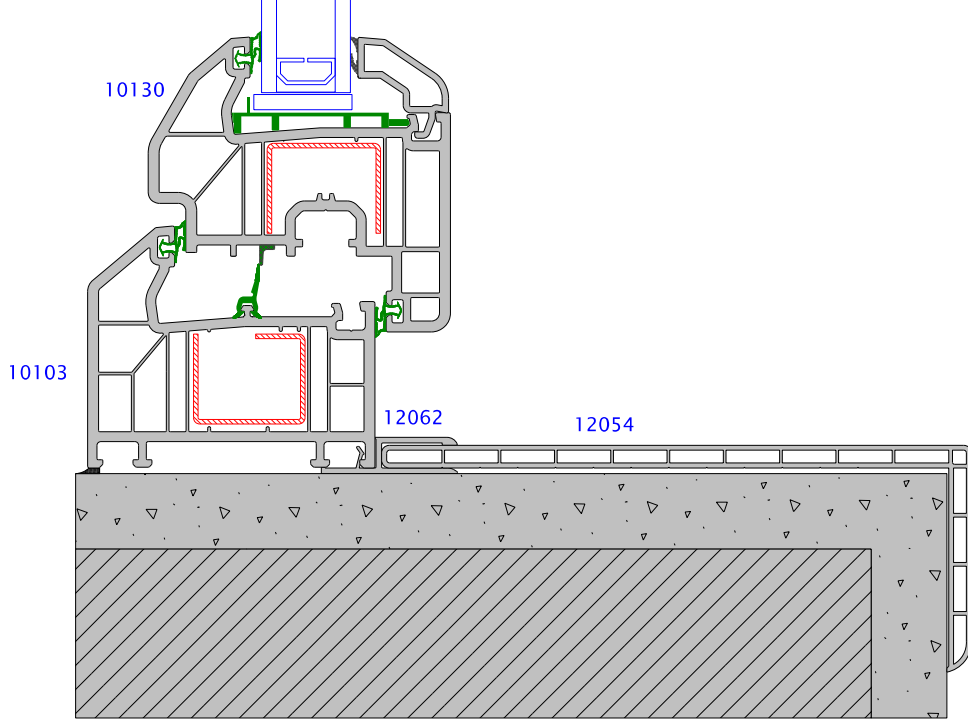
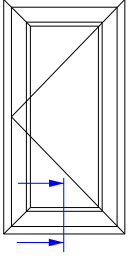

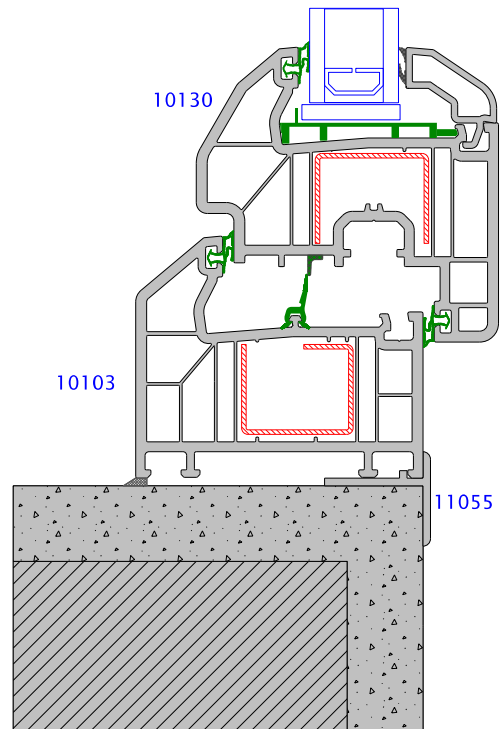
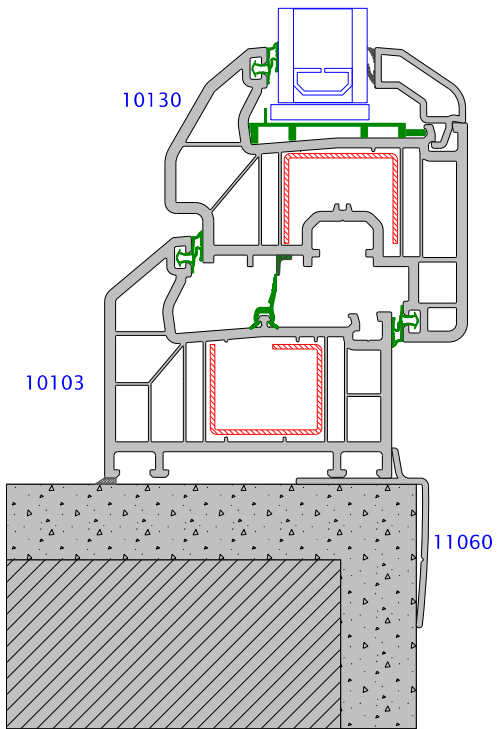
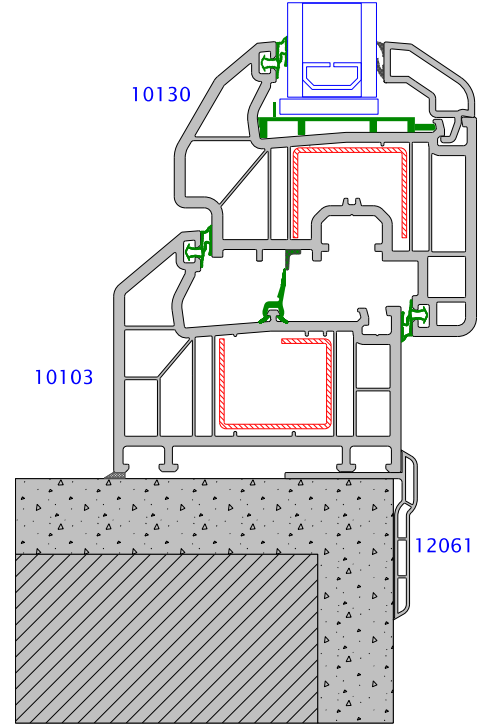
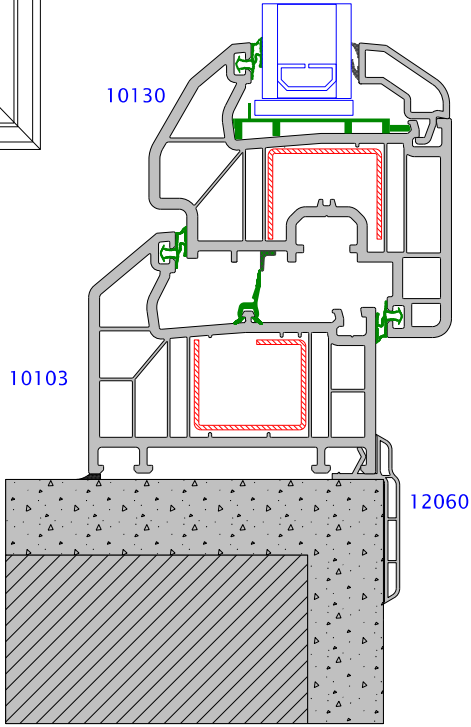
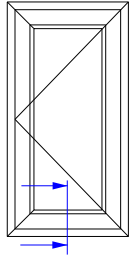

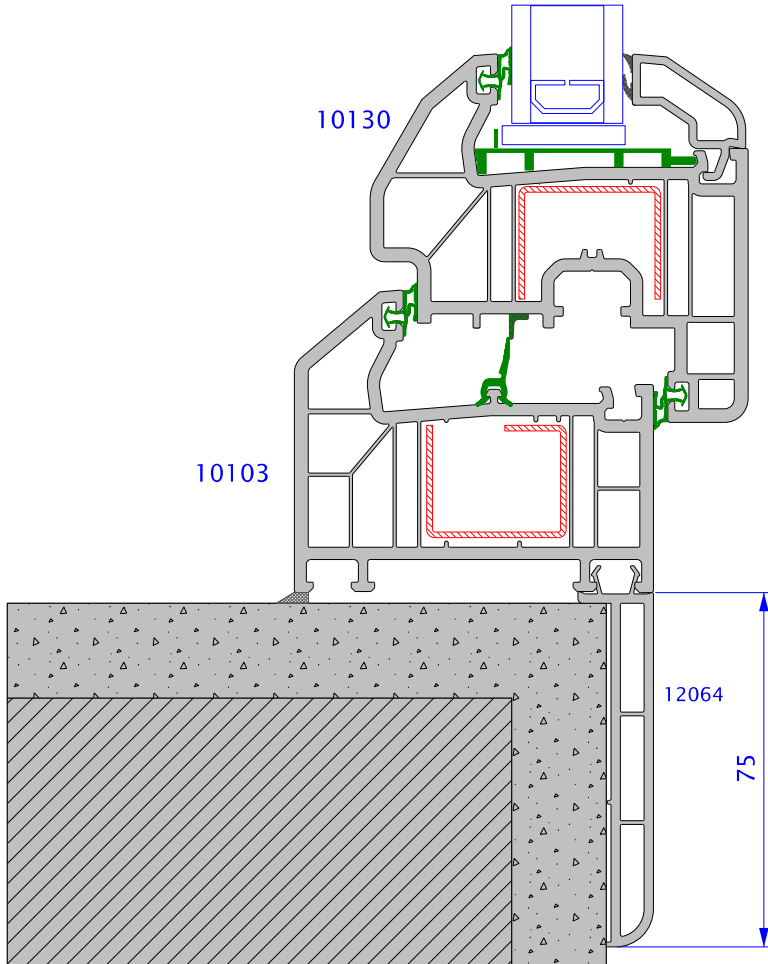
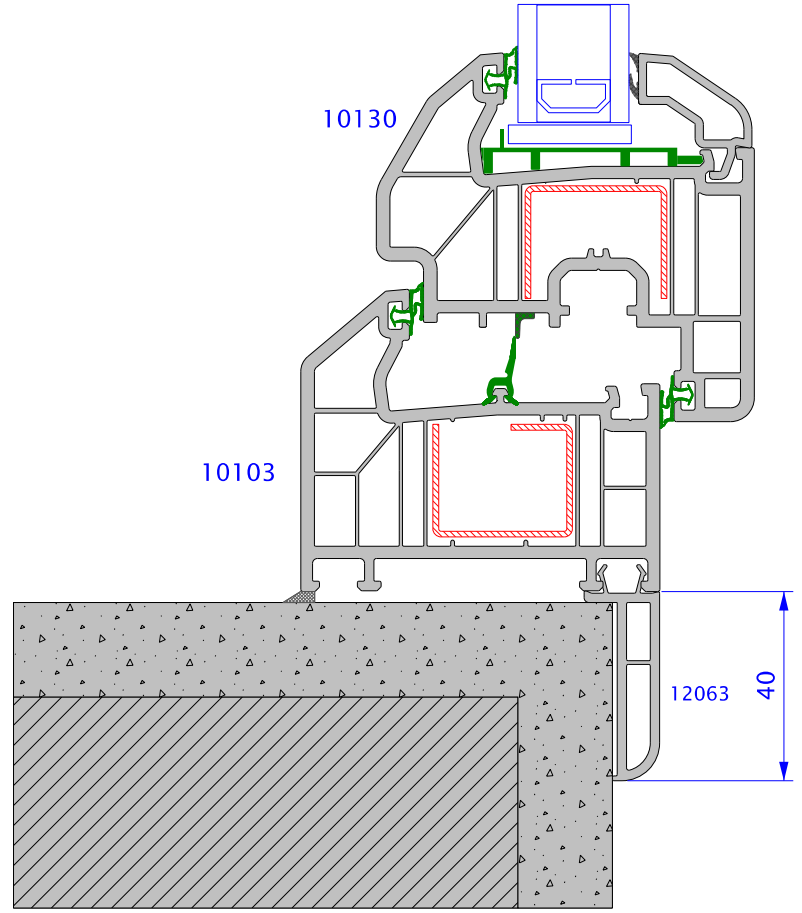
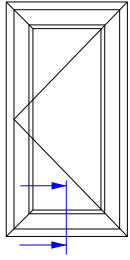



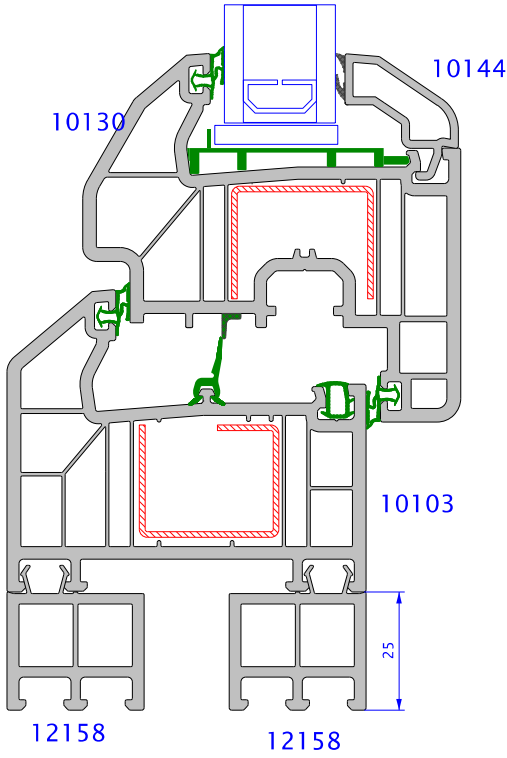
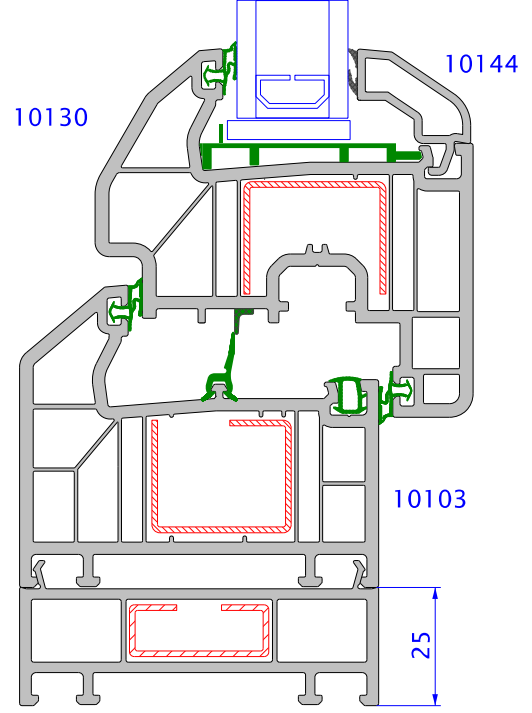
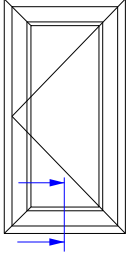

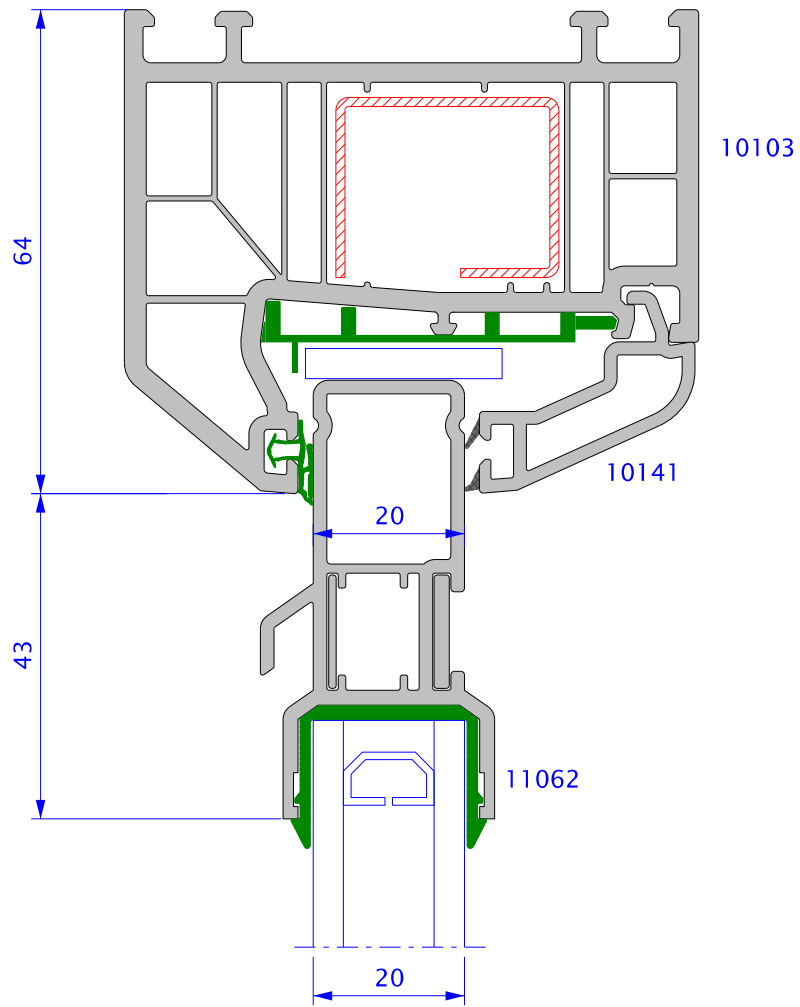
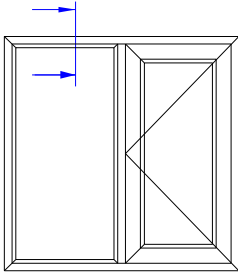

**winsa**<sup>®</sup>  
[www.winsa.com.tr](http://www.winsa.com.tr)